



# USE AND MAINTENANCE MANUAL

TRANSLATION OF THE ORIGINAL INSTRUCTIONS — ENGLISH

## “S”

GE S-6000 YDM (STAGE V)

GE S-6500 YDT (IP54) (STAGE V)

- Gruppo Elettrogeno
- Generating Set
- Groupe Electrogene
- Grupos Electrógenos
- Stromerzeuger
- Grupo Gerador
- Генераторная Установка
- Stroomaggregaten
- Skupina generátoru

Codice  
Code  
Code  
Codigo  
Kodezahl  
Código  
Код  
Code  
Kód

CK4M30109003

Edizione  
Edition  
Édition  
Edición  
Ausgabe  
Edição  
Издание  
Editie  
Edice

04.2019



MADE IN ITALY



**MOSA Energy**



**0. GENERAL INFORMATION**

M1.1	<i>INTRODUCTION</i> .....	PAG. 4
M1.4	<i>CE MARK</i> .....	PAG. 5
M2	<i>SYMBOLS AND SAFETY PRECAUTIONS</i> .....	PAG. 6
M2.1	<i>WARNINGS</i> .....	PAG. 7
M2.5...	<i>SAFETY RULES</i> .....	PAG. 8

**1. GENERAL INFORMATION OF THE MACHINE**

M0	<i>DESCRIPTION OF THE MACHINE</i> .....	PAG.10
	<i>RECORDING DATA</i> .....	PAG.11

**2. TRANSPORT AND HANDLING**

M3	<i>MACHINE UNPACKING</i> .....	PAG.12
M4.1	<i>TRANSPORT AND HANDLING COVERED UNITS</i> .....	PAG.13

**3. INSTALLATION AND USE**

M2.7	<i>INSTALLATION</i> .....	PAG.14
M2.6	<i>INSTALLATION ADVICES</i> .....	PAG.15
M20	<i>SET-UP FOR OPERATION DIESEL ENGINE</i> .....	PAG.19
	<i>EARTHING</i> .....	PAG.20
M21	<i>STARTING AND STOPPING DIESEL ENGINE</i> .....	PAG.21
M31	<i>CONTROLS</i> .....	PAG.23
M37...	<i>USE AS GENERATOR</i> .....	PAG.24
M39.10	<i>ENGINE PROTECTION - INSULATION MONITORING</i> .....	PAG.27
M38.5	<i>REMOTE CONTROL</i> .....	PAG.28

**4. MAINTENANCE**

M40.2...	<i>TROUBLE SHOOTING</i> .....	PAG.29
M43	<i>MAINTENANCE</i> .....	PAG.31
M45	<i>STORAGE AND DISASSEMBLE</i> .....	PAG.33

**5. TECHNICAL INFORMATIONS**

M1.5	<i>TECHNICAL DATA</i> .....	PAG.34
M2.7.1	<i>DIMENSIONS</i> .....	PAG.37
M60	<i>ELECTRICAL SYSTEM LEGENDE</i> .....	PAG.38
M61...	<i>ELECTRICAL SYSTEM</i> .....	PAG.39

Dear Customer,

We wish to thank you for having bought a high quality set. Our sections for Technical Service and Spare Parts will work at best to help you if it were necessary.

To this purpose we advise you, for all control and overhaul operations, to turn to the nearest authorized Service Centre, where you will obtain a prompt and specialized intervention.

☞ In case you do not profit on these Services and some arts are replaced, please ask and be sure that are used exclusively original parts; this to guarantee that the performances and the initial safety prescribed by the norms in force are re-established.

☞ *The use of **non original spare parts will cancel immediately any guarantee and Technical Service obligation.***

### NOTES ABOUT THE MANUAL

Before actioning the machine please read this manual attentively. Follow the instructions contained in it, in this way you will avoid inconveniences due to negligence, mistakes or incorrect maintenance. The manual is for qualified personnel, who knows the rules: about safety and health, installation and use of sets movable as well as fixed.

You must remember that, in case you have difficulties for use or installation or others, our Technical Service is always at your disposal for explanations or interventions.

The manual for Use Maintenance and Spare Parts is an integral part of the product. It must be kept with care during all the life of the product.

In case the machine and/or the set should be yielded to another user, this manual must also given to him.

Do not damage it, do not take parts away, do not tear pages and keep it in places protected from dampness and heat.

You must take into account that some figures contained in it want only to identify the described parts and therefore might not correspond to the machine in your possession.

### INFORMATION OF GENERAL TYPE

In the envelope given together with the machine and/or set you will find: the manual for Use Maintenance and Spare Parts, the manual for use of the engine and the tools (if included in the equipment), the guarantee (in the countries where it is prescribed by law).

The Manufacturer shall not be liable for ANY USE OF THE PRODUCT OTHER THAN THAT PRECISELY SPECIFIED IN THIS MANUAL and is thus not liable for any risks which may occur as a result of IMPROPER USE. The Company does not assume any liability for any damage to persons, animals or property.

Our products are made in conformity with the safety norms in force, for which it is advisable to use all these devices or information so that the use does not bring damage to persons or things.

While working it is advisable to keep to the personal safety norms in force in the countries to which the product is destined (clothing, work tools, etc.).

Do not modify for any motive parts of the machine (fastenings, holes, electric or mechanical devices, others..) if not duly authorized in writing: the responsibility coming from any potential intervention will fall on the executioner as in fact he becomes maker of the machine.

☞ **NOTICE:** *the manufacturer, who keeps the faculty, apart the essential characteristics of the model here described and illustrated, to bring betterments and modifications to parts and accessories, without putting this manual uptodate immediately.*



Any of our product is labelled with CE marking attesting its conformity to applicable directives and also the fulfillment of safety requirements of the product itself; the list of these directives is part of the declaration of conformity included in any machine standard equipment.

Here below the adopted symbol:



ENGLISH

ENGLISH

CE marking is clearly readable and unerasable and it can be either part of the data-plate.

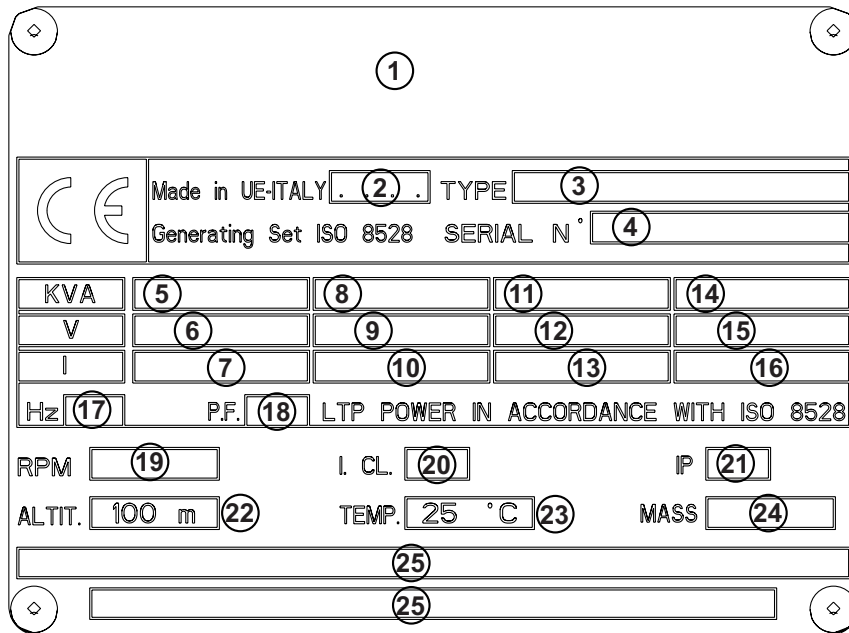

- |  |                                      |
|--|--------------------------------------|
| 1. Name or brand supplier              | 14. Power (kVA/kW)                   |
| 2. Year of production                  | 15. Rated voltage (V)                |
| 3. Generating Set model                | 16. Rated current (A)                |
| 4. Serial number   registration number | 17. Rated frequency                  |
| 5. Power (kVA/kW)                      | 18. Power factor cosφ                |
| 6. Rated voltage (V)                   | 19. Engine rated speed               |
| 7. Rated current (A)                   | 20. Insulation class                 |
| 8. Power (kVA/kW)                      | 21. IP degree protection             |
| 9. Rated voltage (V)                   | 22. Rated altitude (above sea level) |
| 10. Rated current (A)                  | 23. Max ambient temperature          |
| 11. Power (kVA/kW)                     | 24. Dry weight (kg)                  |
| 12. Rated voltage (V)                  | 25. Any additional information       |
| 13. Rated current (A)                  |                                      |

Furthermore, on each model it is shown the noise level value; the symbol used is the following:

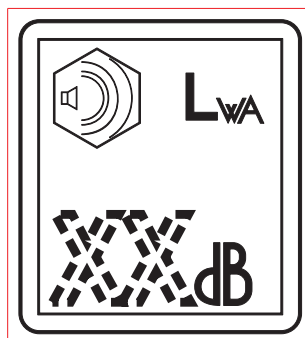



The indication is shown in a clear, readable and indeleble way on a sticker.

**SYMBOLS IN THIS MANUAL**

- The symbols used in this manual are designed to call your attention to important aspects of the operation of the machine as well as potential hazards and dangers for persons and things.  
Moreover, this symbolism intends to draw your attention with the aim to give you indications for a correct use and, as a result, to obtain a good operation of the machine or equipment used.

**SAFETY PRECAUTIONS**

 **DANGEROUS**  
This heading warns of an immediate danger for persons as well for things. Not following the advice can result in serious injury or death.

 **WARNING**  
This heading warns of situations which could result in injury for persons or damage to things.

 **CAUTION**  
To this advice can appear a danger for persons as well as for things, for which can appear situations bringing material damage to things.

 **IMPORTANT**

 **NOTE**

 **ATTENTION**  
These headings refer to information which will assist you in the correct use of the machine and/or accessories.

**SIMBOLS**

 **STOP** - Read absolutely and be duly attentive

 Read and pay due attention





**DANGER**

 **GENERAL ADVICE** - If the advice is not respected damage can happen to persons or things.

 **HIGH VOLTAGE** - Attention High Voltage. There can be parts in voltage, dangerous to touch. The non observance of the advice implies life danger.

 **FIRE** - Danger of flame or fire. If the advice is not respected fires can happen.

 **HEAT** - Hot surfaces. If the advice is not respected burns or damage to things can be caused.

 **EXPLOSION** - Explosive material or danger of explosion. In general. If the advice is not respected there can be explosions.

 **ACIDS** - Danger of corrosion. If the advice is not respected the acids can cause corrosions with damage to persons or things.

 **PRESSION** - Danger of burns caused by the expulsion of hot liquids under pressure.

**PROHIBITIONS**

It is prohibited to smoke while filling the tank with fuel.

 The cigarette can cause fire or explosion. If the advice is not respected fires or explosions can be caused.

It is prohibited to use water to quench fires on the electric machine

 If the advice is not respected fires or damage to persons can be caused.

**Use only with non inserted voltage -**

 It is prohibited to make interventions before having disinserted the voltage.

 **ACCES FORBIDDEN** to non authorized people.

**ADVICE**

**Use only with safety clothing -**

 It is compulsory to use the personal protection means given in equipment.

 **WRENCH** - Use of the tools. If the advice is not respected damage can be caused to things and even to persons.



**FIRST AID.** In case the operator should be sprayed by accident, from corrosive liquids a/o hot toxic gas or whatever event which may cause serious injuries or death, predispose the first aid in accordance with the ruling labour accident standards or of local instructions.

Skin contact	Wash with water and soap
Eyes contact	Irrigate with plenty of water, if the irritation persists contact a specialist
Ingestion	Do not induce vomit as to avoid the intake of vomit into the lungs, send for a doctor
Suction of liquids from lungs	If you suppose that vomit has entered the lungs (as in case of spontaneous vomit) take the subject to the hospital with the utmost urgency
Inhalation	In case of exposure to high concentration of vapours take immediately to a non polluted zone the person involved



**FIRE PREVENTION.** In case the working zone, for whatsoever cause goes on fire with flames liable to cause severe wounds or death, follow the first aid as described by the ruling norms or local ones.

EXTINCTION MEANS	
Appropriated	Carbonate anhydride (or carbon dioxide) powder, foam, nebulized water
Not to be used	Avoid the use of water jets
Other indications	Cover eventual shedding not on fire with foam or sand, use water jets to cool off the surfaces close to the fire
Particular protection	Wear an autorespiratory mask when heavy smoke is present
Useful warnings	Avoid, by appropriate means to have oil sprays over metallic hot surfaces or over electric contacts (switches, plugs, etc.). In case of oil sprinkling from pressure circuits, keep in mind that the inflamability point is very low.

## GENERAL SAFETY INSTRUCTIONS

**NOTE:** the information contained in this manual are subject to change without notice.

The instructions in this manual are intended as indicative only. It is the responsibility of the owner/operator to evaluate risks and potential damages in relation to the use of the product in the specific conditions of application. Remember that the non observance of the indications of this manual may result in damage to people or things.

In all cases, however, it is understood that the use shall be in compliance with the applicable laws/regulations.

- Before operating the machine, read carefully the safety instructions contained in this manual and other manuals supplied (engine, alternator, etc.).
- All operations, handling, installation, use, maintenance, repair should be carried out by authorized and qualified personnel.
- When operating, wear personal protective equipment (PPE): footwear, gloves, helmet, etc..
- The owner is responsible for maintaining the equipment in safe conditions.

### Use only in perfect technical conditions

The machinery or equipment must be used in perfect technical condition. Remove immediately any defects that may affect the safe conditions of use.

- Before starting to use this equipment it is important to take knowledge of all the controls of the machine, all its functions and its correct installation in order to avoid accidents to people and damage to the machine itself. In particular, it is important to know how to stop the equipment quickly in case of emergency.
- Do not allow the use of the machine to people unless previously instructed with all the information for a proper, safe use.
- Forbid the access in the operational area to non authorized personnel, children and pets so as to protect them from possible injury caused by any part of the machine.

## SAFETY PRECAUTIONS DURING HANDLING AND TRANSPORTATION

- Lift the machine using only the points allocated for this function.  
The lifting eye (or eyes) and the correct positioning of the forks of the forklift are marked with specific adhesives.
- Clear the operational area of possible obstacles and all unnecessary personnel.
- Always use lifting equipment properly sized and controlled by enabled bodies.
- It is forbidden to set on the frame of the equipment objects or accessories that alter weight and center of gravity and cause stresses not foreseen to the lifting points.
- Do not submit the machine and the lifting equipment to swinging or shock which may transmit dynamic stress to the structure.

### Equipments with trailers or site tows

- Never drag the machine without trailer (or site tow)
- Check for a correct assembly of the machine to the towing device.
- Always make sure that the hook of the vehicle is suitable for towing of the total mass of the trailer.
- Do not tow the trailer if the coupling devices are worn or damaged.
- Check for proper tire pressure.

- Do not replace the tires with types different from the original ones.
- Check that the brakes and the optical signaling of the trailer are working properly.
- Verify that the bolts of the wheels are in place and well tightened.
- Do not park the machine (on trailer or site tow) on a steep slope.  
For the stops, not followed by a work session, always engage the parking brake and / or block the wheels by means of wheel chocks.
- Do not tow the trailer on bumpy roads.
- Do not exceed the maximum permissible speed on public roads of 80 km/h with the trailer, in any case comply with the legislation applicable in the country of use.
- Do not use the site tow on public roads, this is intended for use only in private and delimited areas. The maximum permitted speed is 40 km/h on smooth surfaces (asphalt or concrete), adapt in each case the speed to the type of ground.

## SAFETY PRECAUTIONS DURING INSTALLATION AND USE

- Always locate the machine on a flat and solid ground, so as to avoid tipping, slipping or falling during operation. Avoid using the machine on slopes greater than 10 degrees.
- Make sure the area immediately surrounding the machine is clean and free from debris.
- Connect the machine to an earthing system according to the regulations in force at the place of installation. Use the ground terminal on the front of the machine.
- Do not use the machine with wet or damp hands and / or clothing.
- Use plugs suitable for the output sockets of the machine and make sure that electrical cords are in good condition.
- The machine must always be positioned so that the exhaust gases are dispersed in the air without being inhaled by people or living beings.
- If you use the machine indoors is necessary that the installation is designed and built by skilled technicians in a workmanlike manner.
- During normal operation, keep doors closed. The access to the internal parts should be allowed only for maintenance reasons.
- Do not place objects or obstructions in the vicinity of the air intakes and air outlets, a possible overheating of the generator could cause a fire.
- Keep area near to the muffler free from objects such as rags, paper, cardboard. The high temperature of the muffler could cause the burning of objects and cause fire.
- Immediately stop the machine in case of malfunction.  
Do not restart the machine without first having found and fixed the problem.



**SAFETY PRECAUTIONS DURING MAINTENANCE**

- Make use of **qualified** personnel to carry out maintenance and troubleshooting.
- It is mandatory to stop the engine before performing any maintenance on the machine.
- Always use protective devices and suitable equipment.
- Do not touch the engine, the exhaust pipes and the muffler during operation or immediately after. Allow the engine to cool before performing any operation.
- With the machine running pay attention to moving parts such as fans, belts, pulleys.
- Do not remove the protections and the safety devices unless absolutely necessary, restore them after completion of the maintenance or repair.
- Do not refuel while the engine is running or hot. Do not smoke or use naked flames when refueling.
- Refuel only outdoors or in well ventilated areas.
- Avoid spilling fuel, especially on the engine. Clean and dry any leaks before restarting the machine.
- Slowly unscrew the cap of the fuel tank and put it back always after refueling.
- Do not fill the tank completely to allow for expansion of the fuel inside.
- Do not remove the radiator cap when the engine is running or still hot, the coolant may spurt out and cause serious burns.
- Do not handle the battery without the use of protective gloves, the battery fluid contains sulfuric acid, which is very corrosive and dangerous.
- Do not smoke, avoid any naked flames or sparks near the battery, the vapors exhaled could cause the battery to explode

**ADDITIONAL PRECAUTIONS FOR LIGHTING TOWERS****ATTENTION**

The lighting tower is designed to be used with a generating set or with a fixed mass on its base. The weight and positioning of the generating set on the base are essential for the safety of the lighting tower. Failure to comply with this provision causes a serious danger of tipping or instability during operation and during handling with site tow. If necessary, contact the service.

**SAFETY PRECAUTIONS DURING HANDLING AND TRANSPORTATION**

- Before moving a lighting tower lower the telescopic mast and block properly all movable parts such as the access doors, the mast, the outriggers, the floodlights.
- Check the fastening of the wheels of the trolley.

**SAFETY PRECAUTIONS DURING INSTALLATION AND USE**

- Make sure the area above the lighting tower is free from overhead cables or other obstacles.
- Before raising the mast extract the outriggers located at the sides of the machine. Acting on the outriggers level the lighting tower making use of the bubble, so as to bring the equipment in a horizontal position. Make sure that the tower rests securely on the outriggers. If the lighting tower is mounted on road trailer pull the handbrake.
- Do not operate the lighting tower if the wind speed exceeds the safe speed indicated or if it is expected the arrival of storms or thunderstorms in the area.
- Lower the telescopic mast when the tower is not used.
- Always check the good condition of the power cable before connecting the lighting tower to the generating set.
- Do not touch and do not place objects on the lamps during operation or immediately after use. The lamps become very hot.
- Do not turn on the lamps without the protective glass or with the same broken or damaged.
- Make sure all the ropes and the manual winch are in perfect condition.
- Place the lighting tower in order to avoid that the winch can receive shocks which may cause damage to the automatic brake.

**SAFETY PRECAUTIONS DURING MAINTENANCE**

- Turn off the generating set or unplug the power cable before carrying out any type of maintenance on the lighting tower.
- Always cut off power to the lamps and wait for their cooling before performing any maintenance or replacement.
- Before carrying out any type of maintenance or repairs on the generating set refer to the manual of the generating set and the other manuals supplied.

The generating set is a unit which transforms the mechanical energy, generated by endothermic engine, into electric energy, through an alternator.

The model GE S-6000 / GE S-6500 is a compact and silent diesel generating set, facilmentelt is easily transported using a trolley.

The design incorporates a steel structure with engine and alternator mounted on anti-vibration dampers to increase service life and reduce noise, whilst a steel frame provides protection for the complete machine. The fuel tank and battery starter complete the main parts of the machine.

The recessed control panel houses the sockets and machine controls.

Suitable for a wide range of uses in general construction, equipment rental, events and standby applications.

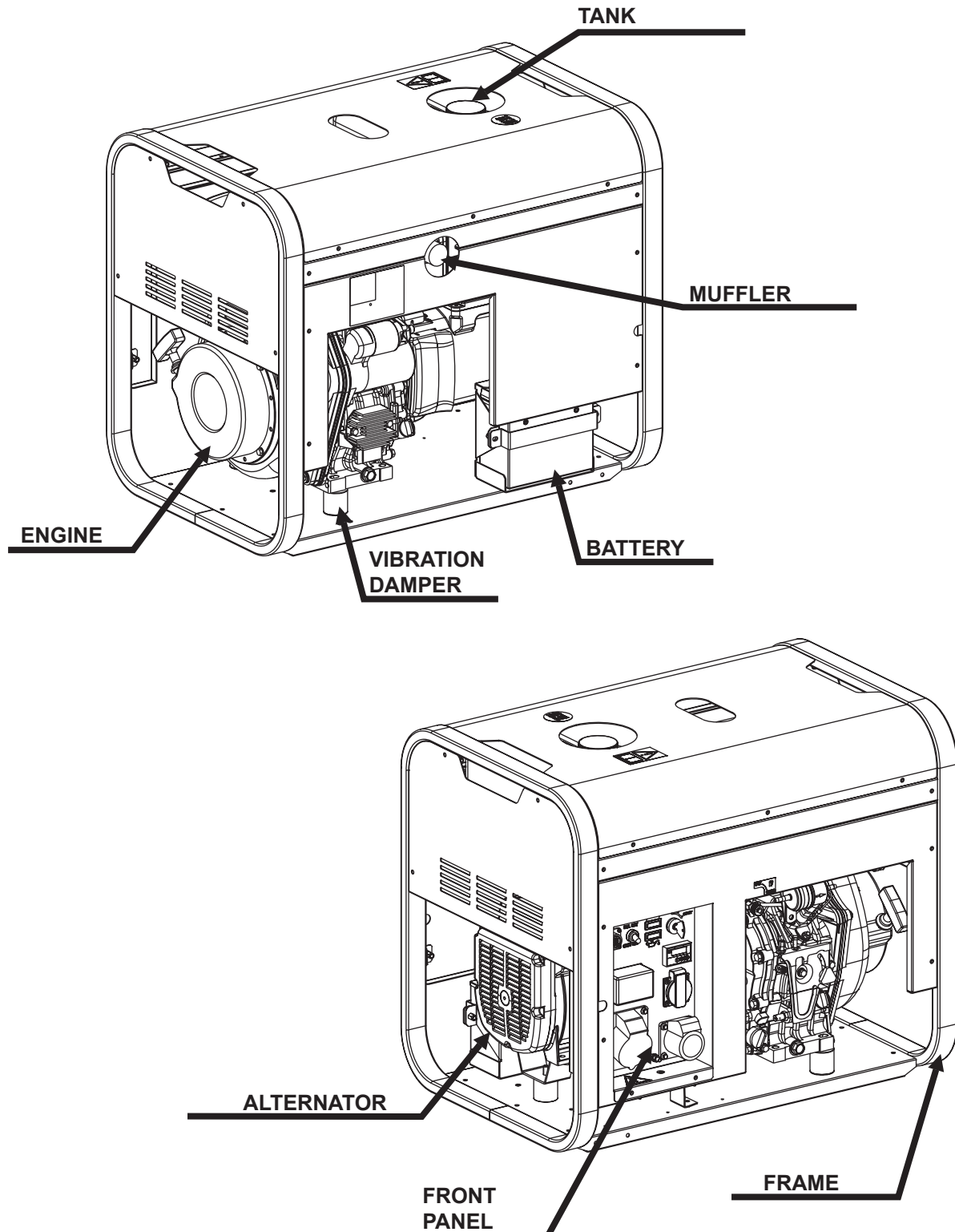

The manual is for the range of machines indicated on the front cover.  
With the scope to facilitate the search of the spare parts and maintain information of the bought machine, is necessary to record some data.

Please write the requested data inside the squares to side:

- 1. Model of machine
- 2. Serial number of the machine
- 3. Serial number of the engine
- 4. Name of the dealer where bought the machine
- 5. Address of the dealer
- 6. Phone number of the dealer
- 7. Date of the bought machine
- 8. Notes

RECORDING DATA

1. \_\_\_\_\_  
\_\_\_\_\_

2. \_\_\_\_\_  
\_\_\_\_\_

3. \_\_\_\_\_  
\_\_\_\_\_

4. \_\_\_\_\_  
\_\_\_\_\_

5. \_\_\_\_\_  
\_\_\_\_\_

6. \_\_\_\_\_  
\_\_\_\_\_

7. \_\_\_\_\_  
\_\_\_\_\_

8. \_\_\_\_\_  
\_\_\_\_\_  
\_\_\_\_\_  
\_\_\_\_\_  
\_\_\_\_\_  
\_\_\_\_\_  
\_\_\_\_\_  
\_\_\_\_\_





**NOTE**

ENGLISH

ENGLISH

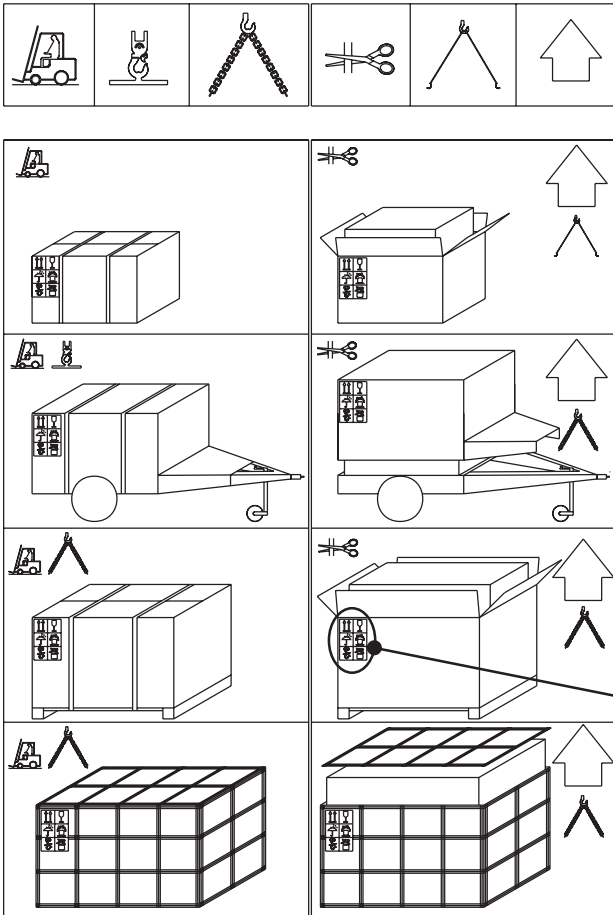

Be sure that the lifting devices are: correctly mounted, adequate for the weight of the machine with its packaging, and conforms to local rules and regulations. When receiving the goods make sure that the product has not suffered damage during the transport, that there has not been rough handling or taking away of parts contained inside the packing or in the set. In case you find damages, rough handling or absence of parts (envelopes, manuals, etc.), we advise you to inform immediately our Technical Service.



For eliminating the packing materials, the User must keep to the norms in force in his country.

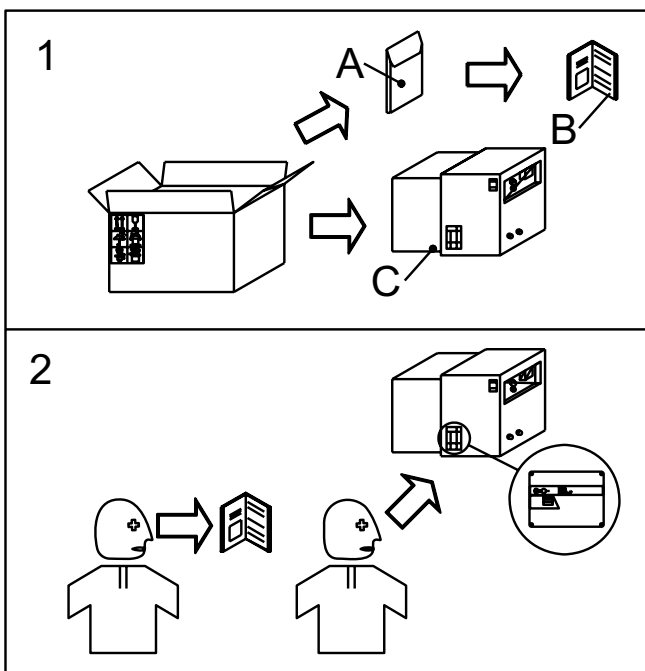
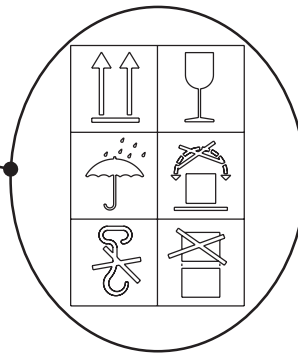

- 1) Take the machine (C) out of the shipment packing. Takeout of the envelope (A) the user's manual (B).
- 2) Read: the user's manual (B), the plates fixed on the machine, the data plate.





## ATTENTION

Transportation must always take place with the engine off, electrical cables and starting battery disconnected and fuel tank empty. Be sure that the lifting devices are: correctly mounted, adequate for the weight of the machine with its packaging, and conform to local rules and regulations.

Only authorized persons involved in the transport of the machine should be in the area of movement.

**DO NOT LOAD OTHER PARTS WHICH CAN MODIFY WEIGHT AND BARICENTER POSITION.**

**IT IS STRICTLY FORBIDDEN TO DRAG THE MACHINE MANUALLY OR TOW IT BY ANY VEHICLE (model with no CTM accessory).**

If you did not keep to the instructions, you could damage the structure of the machine.

ENGLISH

ENGLISH

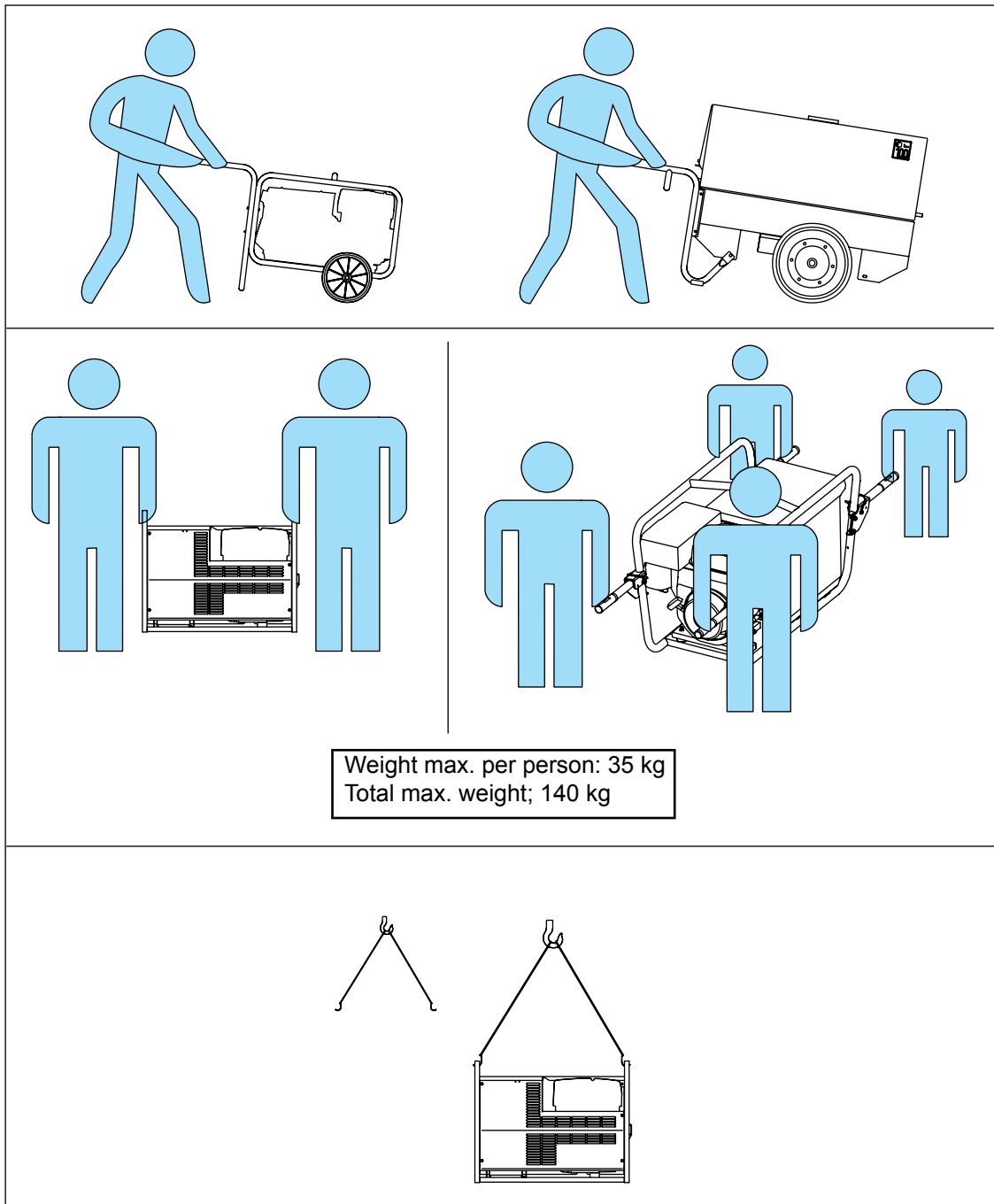

Weight max. per person: 35 kg  
Total max. weight; 140 kg



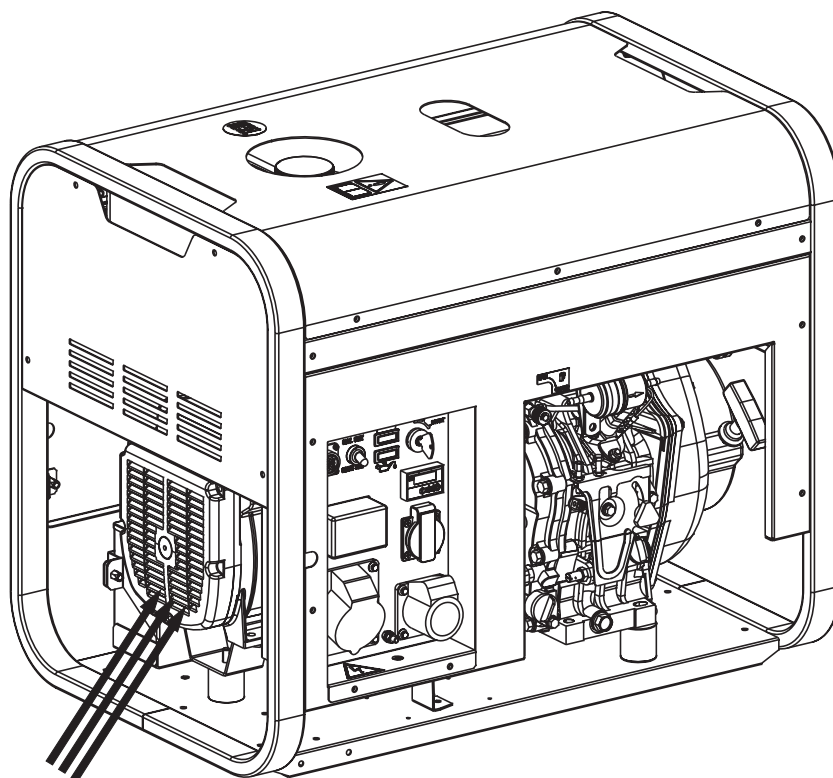
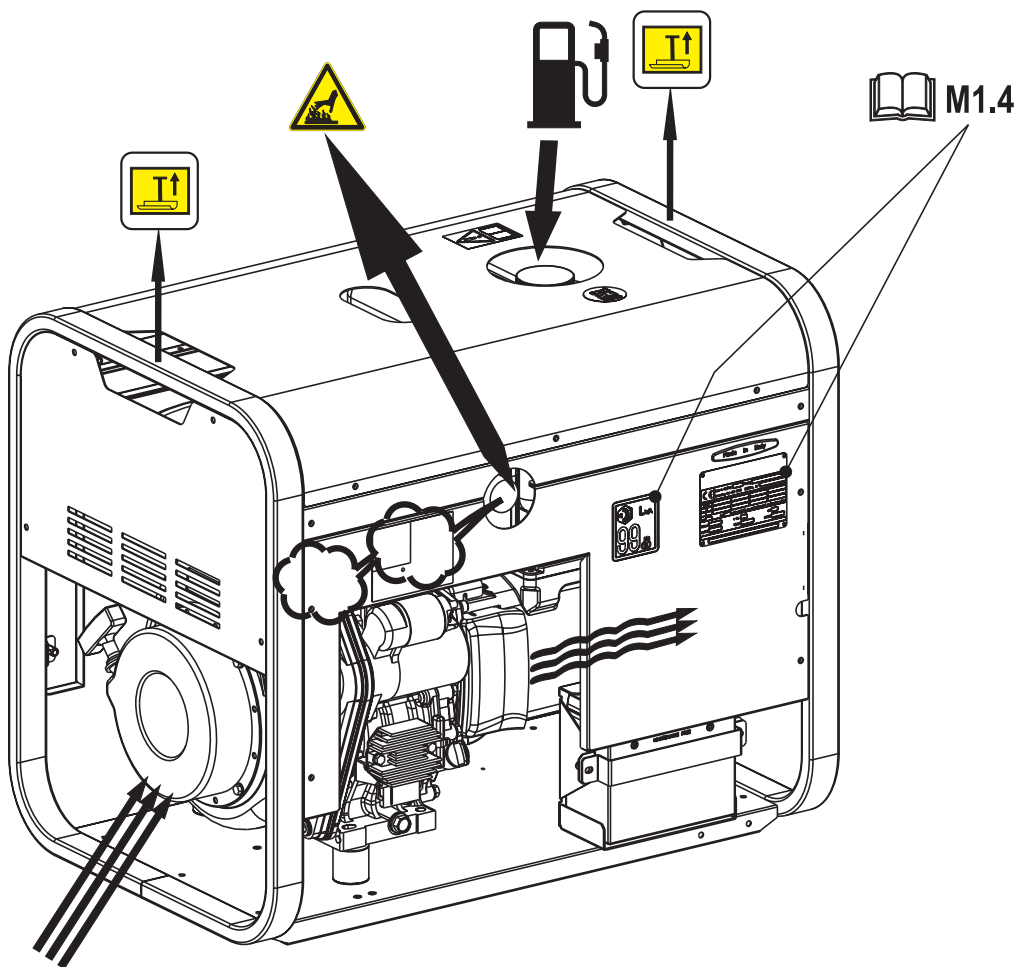

**GENERAL INSTALLATION CRITERIA**

Installation of a genset has to be planned by qualified and trained technicians, it has to be carried out by a competent organization with qualified personnel and proper equipment.

 <b>ATTENTION</b>
<p>Faulty installation can create damage to the genset and the User system, and injury to persons. It is compulsory to install the genset according to the norms in force in the country of installation.</p> <p>The installing company must provide a conformity declaration stating that installation has been carried out duly and according to plans and to norms in force.</p>

Before proceeding with installation the following conditions have to be checked:



- Genset has been selected according to needs of the electrical load and to environmental conditions (temperature, altitude and humidity);
- Genset location is of appropriate dimensions and allows accessibility to genset for maintenance and/or necessary repairs;
- If genset is indoors, ensure there is enough air for engine combustion, for genset cooling (radiator and generator), and sufficient ventilation;
- If genset is indoors, a system of expulsion for engine exhaust gas is provided;
- Personnel safety has been carefully considered;
- Noise-level issues have been carefully considered;
- Fuel and lubricant stocking issues have been considered in accordance to norms in force in the country of installation.

 <b>INFORMATION</b>
<p>Italian and European norms define specific characteristics referring to the premises in which genset should be located, indicating possible positioning, minimum dimensions, etc.</p> <p>For any doubt referring to installation location contact our technical sales office.</p>



**OUTDOOR INSTALLATION**

 <b>ATTENTION</b>
<p>All generating sets are equipped with a control system that is NOT influenced by standard environmental factors and is able to stop the unit in case of anomalous values in the fundamental parameters.</p> <p>In order to avoid unexpected black-outs or other potentially dangerous situations, the below installation indications must be followed.</p>

**ENVIRONMENTAL CONDITIONS**

 <b>ATTENTION</b> 
<p>Open gensets (SKID) have to be located in an area protected from rain, snow, high humidity and direct exposure to the sun. Rain or high humidity on GE genset alternator, in particular during operation, cause an increase in voltage output, winding faults, electric discharge towards ground, with damage to the genset and injury to persons. Dust, in particular saline dust, must be avoided. In case radiator or air filters are obstructed, there is the risk that genset will overheat or be damaged. Aspiration grills must not be obstructed by leaves, snow, etc.</p>

**OUTPUT OF FUMES IN OPEN AIR CONDITIONS**

 <b>DANGER</b> 
<p>Genset must be positioned so that exhaust gas is diffused without being inhaled by any living being. Engine exhaust gas contains carbon monoxide, which is harmful to one's health, and in big quantities can cause intoxication and death. Local norms in force have to be respected.</p>

**SAFE DISTANCE**

## ATTENTION

A safe distance has to be kept between genset and fuel deposits, inflammable goods (cloths, paper, etc.), chemicals, according to indications provided by the authority in charge. In order to avoid potentially dangerous situations, area surrounding genset should be isolated so that unauthorized people will not be able to get close to the unit. Even if MOSA gensets are manufactured according to electromagnetic compatibility norms, we suggest NOT to install the genset near machinery that can be influenced by magnetic fields.

**FIXING**

In order to absorb vibrations produced by genset, it should be fixed to a surface with sufficient rigidity, isolated against vibrations towards other structures and with a mass equal to at least three times the genset mass.  
DO NOT locate the genset on terraces or raised levels, if its characteristics have not been previously verified as suitable.

## NOTE

**When using a genset it is advisable to adopt precautions to avoid that fuel, lubricant and other engine liquids may accidentally cause soil pollution. The most recent generators are designed to retain possible liquid leakages, hence no specific measures are needed in this regard. In case of doubts concerning your genset do not hesitate to contact our technical sales office.**

**FIXED OUTDOOR INSTALLATION**

If a shelter is used to protect the genset (see figure), it should NOT be attached to it. Even if a shelter is temporary the below indications should be followed:

## ATTENTION

Engine and alternator when in operation produce heat:

- Shelter should NOT obstruct normal cooling of components;
- Exhaust gas should be directed in order to avoid the possibility that alternator and engine fan inhale it;
- Shelter should be made of fireproof material, as embers may come out of the exhaust pipe;
- Never cover or wrap up genset with plastic sheets or other material while operating. If genset is off, make sure engine has cooled before you cover it, or else there may be risk of damage to the genset or may catch fire.

**TEMPORARY OUTDOOR INSTALLATION**

Indications given for fixed installation have to be followed. If genset is not positioned correctly, vibrations transmitted to the baseframe may cause the genset to move, this may occur while the genset has a load inserted, take on all necessary precautions to avoid this.

Sample of outdoor installation with shelter

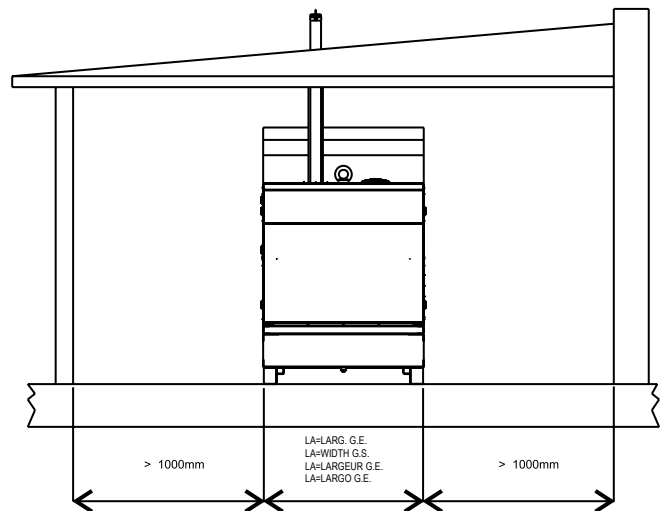



Sample of outdoor installation with shelter

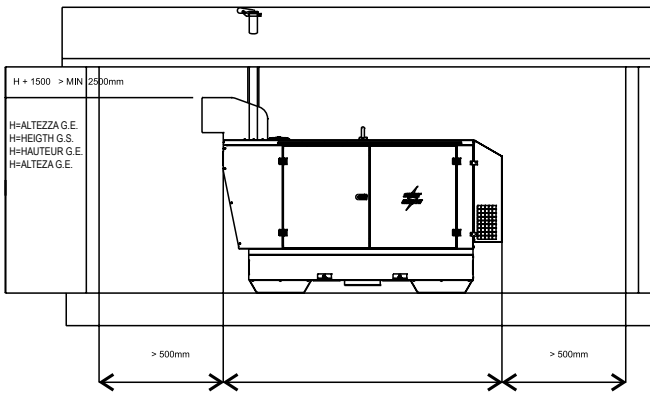

Floor should be levelled and suitable to sustain genset weight. Thresholds on doors and openings should have a barrier in order to avoid liquids leaking. In case it is not possible to provide a door with a barrier, the genset should have a collection base appropriate for the quantity of liquid it contains, in any case dimensions of collection base must be in accordance to the laws in force in country of installation.

**INDOOR INSTALLATION**

In order to avoid endangering or damaging genset following indications must be followed. Genset installation location has to be in accordance to the norms in force.

ref.	Description
1	Generating set
2	Auxiliary aspirator
5	Exhaust pipe
7	Exhaust pipe protection and insulation
8	Raincover and anti-intrusion grid
9	Exhaust conduit
11	Location area with isolated foundation
12	Air inlet with anti-intrusion grid
13	Entrance door
14	Containment step

Minimum suggested dimension table	
A	Length G.E. + 1000 mm
B	Width G.E. + 2000 mm
C	Width G.E. + 200 mm
D	Length G.E. + 400 mm
E	Width G.E. + 400 mm
H	Height G.E. + 1500 mm (>2500 mm)

Note: dimensions required by norms in force have to be respected in any case.

**SURFACE AREA**

The best solution is to create a base isolated from the rest of the structure, on which the genset will be located, in order to avoid vibrations being transmitted. The base must be built with reinforced concrete and there must be the possibility to fix the genset to it by using screw anchors or rag bolts. Base dimensions should exceed genset dimensions of at least 200 mm on each side. Base should weigh three times static genset weight (indicated on the technical date).

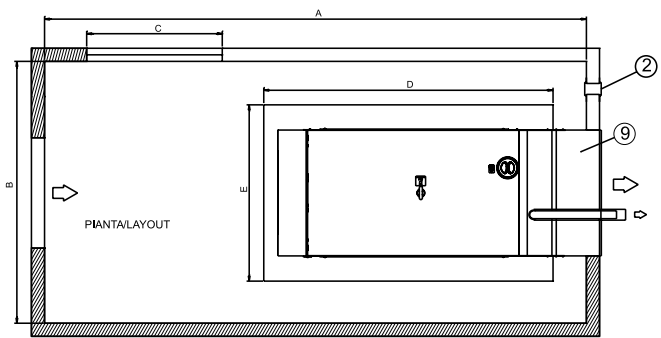
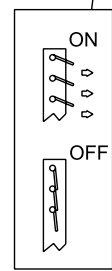
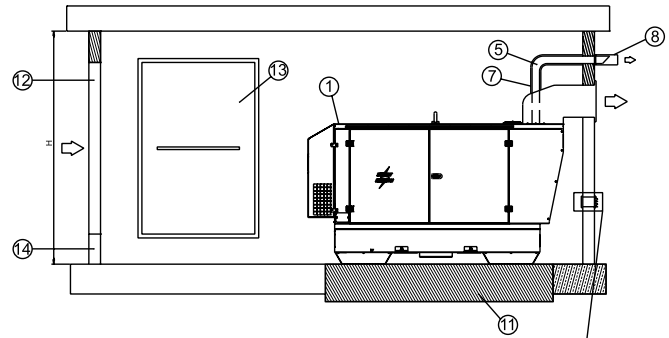

**ROOM OPENINGS AND VENTILATION**

The room should have a ventilation system sufficient enough to avoid stagnation and circulation of overheated air. Openings for incoming and outgoing air should be of appropriate size, considering minimum required air flow and maximum back pressure, values that can be checked on the engine manual. Opening for the air entrance should be near the back part of the genset as close as possible to the ground. If openings for air flow are not aligned with genset it may be necessary to add air conduits to avoid any air dispersion (see figure).

For open gensets installed indoors, we recommend:

- The dimensions of the air outlets be such that they have at least the same area of the radiator;
- the dimensions of the windows for air outlet is at least on the surface of the radiator.
- The dimensions of the air inlets be such that they have at least the same area of the radiator +10% for gensets up to 130 kVA or +25% for gensets beyond 130 kVA;

For canopied gensets installed indoors, we recommend:

- The dimensions of the air outlets be such that they have at least the same area of the generator air outlets, as indicated at page M2.7 of the present manual;
- The dimensions of the air inlets be such that they have at least the same area of the generator air inlets, as indicated at page M2.7 of the present manual +10% for gensets up to 130 kVA or +25% for gensets beyond 130 kVA;

The opening area has to be calculated considering protection grill surface, in order to insure that remaining free area is sufficient.

Dimensions of openings calculated as above indicated, are the minimum acceptable dimensions in case of L.T.P. use: the pressure remaining after radiator and back pressure must be considered while planning dimensions of the piping.

To calculate the opening section check below drawing:

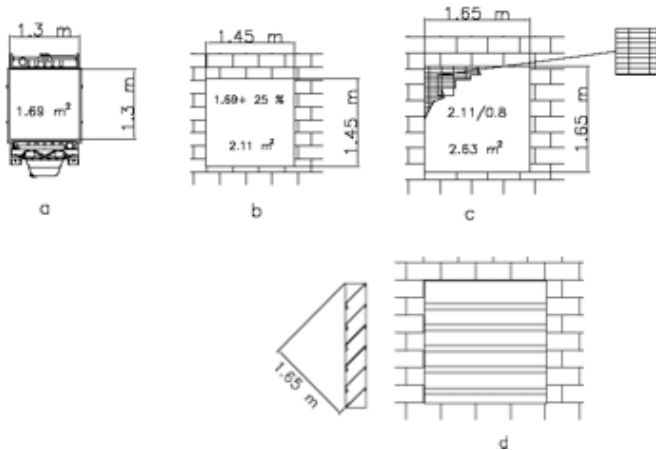

a	Radiator surface
b	Free opening
c	Air flow opening with grill and 80% of open surface
d	Air flow opening with baffle plates

**WARNING:** to avoid reflux of heated air and loss of load, add an air duct between radiator and opening.

To consider the correct quantity of heat to be discharged, loss of heat on duct should be evaluated. If the duct is not appropriately insulated, room-temperature may increase considerably, for this reason it may be necessary to install an electro ventilator for correct air exchange.

Electro ventilator capacity can be calculated as follows:

$$Fan\ Capacity\ [m^3/h] = \frac{Transmitted\ heat\ [Kcal/h]}{0,287 \times \Delta t\ [^{\circ}C]}$$

Considering:

- heat to radiation is indicated on engine/alternator technical data sheet;
- 0.287 is specific heat for each m3 of air at 20°C;
- Δt in °C is usually considered as equal to 5 °C (worst conditions are considered).

**EXHAUST PIPING**

Exhaust piping must be built in accordance to laws in force in the country of installation.

General indications:

- Minimum required thickness: 2.0 mm;
- Diameter of piping has to be calculated considering, length, number of bends, type of exhaust muffler, and any other accessory used on it. **Back pressure should not exceed values provided by manufacturer, as this causes loss of power and damage to the engine.**



## ATTENTION

**Exhaust piping may reach up to 600 °C during operation, therefore it is compulsory to cover piping with appropriate insulation.**

- Exhaust piping should be composed of parts, connected by flanges with gaskets, for easy disassembling and grant maximum tightness.
- Exhaust piping should be connected to engine by a flex that should absorb dilatation and separate fix part from engine piping.
- Exhaust piping should not weigh on engine manifold.



## DANGER

**Engine exhaust gas contains carbon monoxide, harmful to health and in large quantities can cause intoxication or death.**



**BATTERY WITHOUT MAINTENANCE  
(WHERE IT IS ASSEMBLED)**

The supplied battery is generally ready for use.  
Connect the cable + (positive) to the pole + of the battery, by properly tightening the clamp.

In some models the battery should be activated.  
To activate it (fill the included acid) please follow the instructions shown on the manual attached to the battery. When battery is activated, **DON'T** add any other liquid.



**LUBRICANT**

Please refer to the motor operating manual for the recommended viscosity.

Oil filling and level inspections must be carried out with the engine on a flat surface:

1. Remove oil filler cap (24);
2. Pour the oil in and reassemble oil cap;
3. Check the oil level using the dipstick (23); the oil level must be comprised between the minimum and maximum indicators.



**ATTENTION**

It is dangerous to supply too much lube oil to the engine because a sudden increase in engine rpm could be caused by its combustion.



**DRY AIR FILTER**

Check that the dry air filter is correctly installed and that there are no leaks around the filter which could lead to infiltrations of non-filtered air to the inside of the motor.



**OIL BATH AIR FILTER**

Fill the air filter using the same engine oil up to the level indicated on the filter.



**FUEL**



**ATTENTION**



Stop engine when fueling. Do not smoke or use open flames during refuelling operations, in order to avoid explosions or fire hazards.



Fuel fumes are highly toxic; carry out operations outdoors only, or in a well-ventilated environment. Avoid accidentally spilling fuel. Clean any eventual leaks before starting up motor.

Refill the tank with good quality diesel fuel, such as automobile type diesel fuel, for example.

For further details on the type of diesel fuel to use, see the motor operating manual supplied.

Do not fill the tank completely; leave a space of approx. 10 mm between the fuel level and the wall of the tank to allow for expansion.

In rigid environmental temperature conditions, use special winterized diesel fuels or specific additives in order to avoid the formation of paraffin.

**ELECTRICAL CONNECTIONS**



**ATTENTION**



A qualified electrician should carry out electrical connections according to the norms in force.

The electrical connection to the User system is a very important operation: safety and good operation of the genset and User system depend on a correct electrical connection.

Before supplying User system always check:

- that wires connecting gen-set to the user plant are suitable to the supplied voltage and are in accordance to the applicable rules;
- wire type, section and length have been calculated considering environment conditions and in force norms;
- ground is functioning correctly: earth fault relay device works only if this connection is operating;
- that direction of the phases corresponds to the user plant phase rotation, and none of the phases has been accidentally connected to neutral.



## EARTHING WITHOUT GROUND FAULT INTERRUPTER

The protection against electric shock from contact indirect is ensured by the “electrical separation” with equipotential bonding between all the exposed conductive parts of the generating set.

The generating set is **NOT** equipped with a earth leakage circuit breaker because its windings are not connected to ground, hence the machine should **NOT** be intentionally connected to a grounding circuit.

The limitation of the extension of the electric circuit is very important for safety, do not power supply to electric plants with a length greater than 200 meters.

It is important that the power cords of the equipment are equipped with the protective conductor, yellow-green cable, in order to ensure the connection between the exposed conductive parts of the generating set and the equipment; this provision does not apply to the class II equipment (double insulation or reinforced insulation) recognizable by the symbol .

The cables must be suitable environment in which it operates. It should be noted that with temperatures below 5°C PVC cables become stiff and PVC insulation tends to cut to the first fold.

The protection by electrical separation is **NOT** suitable if the machine is destined to supply power complex plants or located in special environments with greater risk of electric shock.

In these cases it is necessary to adopt security measures electricity provided by law.

For EXAMPLE, you can install a GFI (Ground Fault Interrupter or Earth Leakage Circuit Breaker) high sensitivity 30mA, and grounding the Neutral of the generating set: this operation must be performed by a qualified electrician or at a authorized service provider.

The grounding of the generating set is now mandatory to ensure protection against indirect contact by means of the GFI.

Connect the generating set to an earthing system via a cable certain efficiency using the ground terminal (12) on the machine.

## EARTHING WITH GROUND FAULT INTERRUPTER

The grounding connection to an earthed installation **is obligatory** for all models equipped with a differential switch (circuit breaker). In these groups the generator star point is generally connected to the machine’s earthing; by employing the TN or TT distribution system, the differential switch guarantees protection against indirect contacts.

In the case of powering complex installations requiring or employing additional electrical protection devices, the coordination between the protection devices must be verified.

For the grounding connection, use the terminal (12); comply to local and/or current regulations in force for electrical installations and safety

## EARTHING WITH ISOMETER

Machines equipped with insulation resistance monitor allow intentionally not to connect the ground terminal PE (12) to an earthing system.

Located on the front of the machine the insulation resistance monitor has the function of continuously monitoring the ground insulation of live parts.

If the insulation resistance falls below the pre-set fault value, the insulation resistance monitor will interrupt the supply of the connected equipment.

It is important that the power cords of the devices are provided with the green-yellow circuit protective conductor, so as to ensure the bonding among all the grounds of the equipment and the ground of the machine; the latter provision does not apply to equipment with double insulation or reinforced insulation.

**NOTE:** it is possible to connect the PE terminal (12) to an own ground connection. In this case an IT earthing system is accomplished, this means with the active parts isolated from earth and the equipment cases grounded.

In this case, the insulation resistance monitor checks the insulation resistance of the active parts both towards case and ground, for example, the insulation towards ground of the power cables.



Check daily



**NOTE**

Do not alter the primary conditions of regulation and do not touch the sealed parts.

**STARTING**

1) make sure the load plugs are disconnected or that the main switch of machine is open (lever facing down), so as to ensure the motor's start-up without any loads inserted.

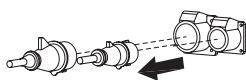

2) Open the fuel cock

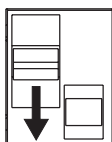

FUEL COCK

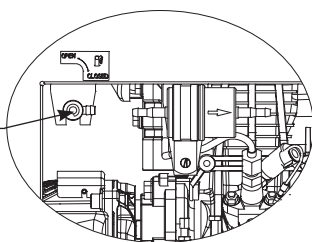

**MANUAL RECOIL**

3) Accelerator lever must be in the "START" position.

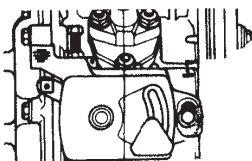

4) hold the starting handle properly and pull until you feel resistance

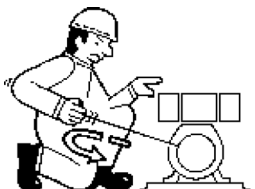

5) then return it slowly

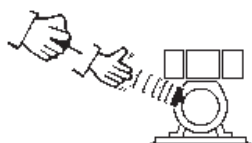

6) push the decompression lever down and release

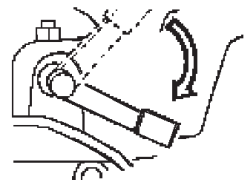

7) hold the starting handle firmly and pull the rope hard and fast. Pull it all the way out. Use two hands if necessary



**ATTENTION:** Allow the start-up knob to re-enter slowly, avoiding having it knock against the motor and thereby damaging the start-up system.

**ELECTRIC START**  
**Start-up from front panel**

- 1) Position the LOCAL START / REMOTE START (I6) selector on LOCAL START (only EAS version)
- 2) Turn the starter key to position "ON". Make sure the battery charge and oil warning lights are lit
- 3) Turn the start-up key (Q1) to the START position, once the engine is started up leave the key, it will reposition itself in "ON".



**In case of unsuccessful start-up, do not insist for longer than 5 seconds. Wait 10 seconds before attempting another start-up.**

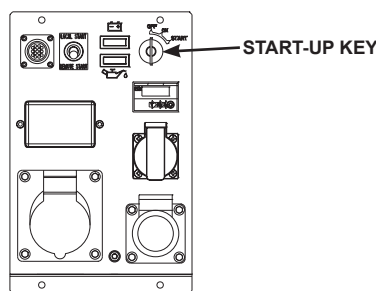

4) After starting let the engine run with no load for a few minutes according to table.

TEMPERATURE	TIME
≤ - 20° C	5'
- 20° C / - 10° C	2'
- 10° C / - 5° C	1'
≥ - 5° C	20"

**Remote start (only EAS version)**

The unit can also be started by means of the remote TCM control device, or through the EAS automatic intervention panel.

- 1) Position the LOCAL START / REMOTE START (I6) selector on REMOTE START;
- 2) check that the emergency stop button is unblocked (where it is assembled);
- 3) Connect to the EAS (B3) connector the TCM or the EAS panel.
- 4) **Start-up with EAS**  
The EAS panel automatically sees to controlling the motor's start-up cycle.  
**The preheating time on the EAS panel is normally set at 10 seconds; for low temperatures, it may be necessary to increase it to 15 or 20 seconds to ensure start-up. Contact an authorized Service Centre or our Technical Service Department directly to modify this setting.**
- 5) **Start-up with TCM**  
Perform the same procedure for start-up from the front panel using the TCM start-up key (Q1).



**ENGINE PROTECTION**



The generator is equipped with protection (engine stop) for low oil pressure. The engine protection is signaled by the light oil (O1).



The battery indicator light, indicates a fault without stopping the engine.

**STOPPING**

**Under normal conditions, use the following procedure:**

- 1) stop the power source, turning off the connected equipment, if they do not have a power switch, open the main switch of the machine (lever facing down)
- 2) allow the engine to run without any load for a few minutes
- 3) move the engine speed lever to the "STOP" position or turn the starter key (Q1) to the position OFF
- 4) shut the fuel cock.

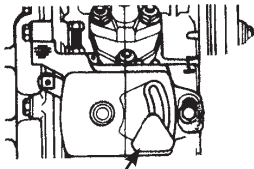

ACCELERATOR LEVER

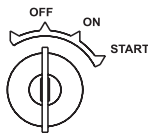

**SHUT-DOWN FROM REMOTE (only EAS version)**

The unit can also be shut down by means of the TCM remote control or EAS panel.



**WARNING**

*The start-up selector (I6) LOCAL START / REMOTE START enables the start-up and stop controls for the selected position.*

*From the REMOTE START position, the start-up key on the front panel is completely disabled; to stop the generator, use the controls on the TCM or EAS panel.*

1. Check that the EAS (B3) connector is connected to the cable from the TCM or EAS panel
2. Verify or position the LOCAL START / REMOTE START (I6) selector on REMOTE START
3. **SHUT-DOWN with EAS**  
The EAS panel automatically sees to controlling the motor shutdown cycle, including the cooling cycle
4. **SHUT-DOWN with TCM**  
Follow the same shutdown procedure described for shutdown from the front panel using the TCM key (Q1).

**EMERGENCY SHUTDOWN**

To shut down the engine in an emergency situation act immediately on the stop lever (28) or the key (Q1) to the OFF position.



**CAUTION**

**RUNNING-IN**

During the first 50 hours of operation, do not use more than 60% of the maximum output power of the unit and check the oil level frequently, in any case please stick to the rules given in the engine use manual.

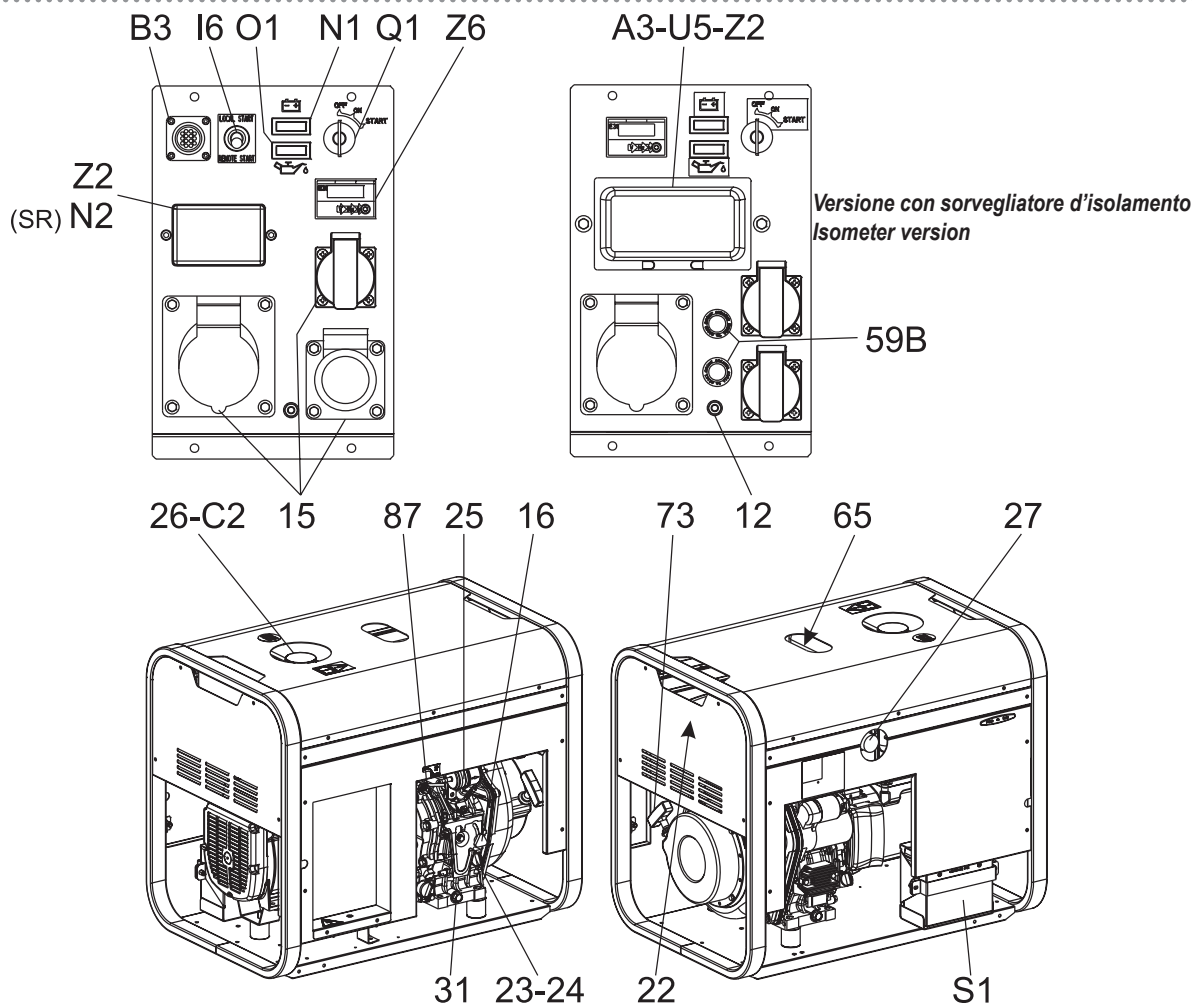

Pos.	Descrizione	Description	Description	Referenzliste
12	Presa di messa a terra	Earth terminal	Prise de mise à terre	Erdanschluss
15	Presa di corrente in c.a.	A.C. socket	Prises de courant en c.a.	Steckdose AC
16	Comando acceleratore (AA)	Accelerator lever (AA)	Commande accélérateur (AA)	Beschleuniger (AA)
22	Filtro aria motore	Engine air filter	Filtre air moteur	Luftfilter Motor
23	Asta livello olio motore	Oil level dipstick	Jauge niveau huile moteur	Oelmess-Stab
24	Tappo caricamento olio motore	Engine oil reservoir cap	Bouchon remplissage huile moteur	Füllverschluß Motoröl
25	Prefiltro combustibile	Fuel prefilter	Préfiltre carburant	Kraftstoffvorfilter
26	Tappo serbatoio	Fuel tank cap	Bouchon réservoir	Füllverschluss Kraftstofftank
27	Silenziatore di scarico	Muffler	Silencieux d'échappement	Auspufftopf
31	Tappo scarico olio motore	Oil drain tap	Bouchon décharge huile moteur	Ablässöffnung Motoröl
59B	Protezione termica corrente aux	Aux current thermal switch	Protection thermique courant aux.	Thermoschutz Hilfsstrom
65	Leva decompressione	Decompression lever	Levier de décompression	Dekompressionshebel
73	Manopola per avviamento (AA)	Starter handle (AA)	Commande manuelle démarrage (AA)	Taste start (AA)
87	Rubinetto carburante	Fuel valve	Robinet de l'essence	Kraftstoffventil
A3	Sorvegliatore d'isolamento	Isometer	Isomètre	Isolationsüberwachung
B3	Connettore EAS	E.A.S. connector	Connecteur E.A.S.	Steckdose E.A.S./Fernstart
C2	Indicatore livello combustibile	Fuel level light	Indicateur niveau carburant	Anzeige Kraftstoffpegel
I6	Selettore Local/Remot START	Start Local/Remote selector	Selecteur Start Local/Remote	Umschalter Fernstart
N1	Spia carica batteria	Battery charge warning light	Voyant charge batterie	Kontrolleuchte Batterielader
N2	Interruttore magnetotermico / differenziale	Thermal-magnetic circuit breaker / Ground fault interrupter	Interrupteur magnétothermique / différentiel	Thermomagnetschalter und GFI
O1	Spia bassa pressione olio	Oil pressure warning light/Oil alert	Voyant lumin. press. huile / oil alert	Kontrolleuchte Oeldruck
Q1	Chiave di avviamento (AE)	Starter key (AE)	Clé de démarrage (AE)	Zündschloß (AE)
S1	Batteria	Battery	Batterie	Batterie
U5	Bobina di sgancio	Relase coil	Bobine de décrochage	Auslösespule
Z2	Interruttore magnetotermico	Thermal-magnetic circuit breaker	Interrupteur magnétothermique	Thermomagnetschalter
Z6	Indicatore digitale multifunzione	Digital multifunction meter	Indicateur numeric multifunction	Multifunktions Digitalanzeige

**WARNING**

*It is absolutely forbidden to connect the unit to the public mains and/or another electrical power source .*



**Access forbidden to area adjacent to electricity-generating group for all non-authorized personnel.**

**WARNING**

For the canopy generator sets provided with doors, the following instruction shall be observed. During the normal operation, the doors of the engine compartment and/or the electrical box shall be kept closed, locked up if possible, as they must be considered in all respects as protection barriers. The access to the internal parts shall occur for maintenance purposes only, by qualified personnel and, in any case, when the engine is stopped.

The electricity-generating groups are to be considered electrical energy producing stations.

The dangers of electrical energy must be considered together with those related to the presence of chemical substances (fuels, oils, etc.), rotating parts and waste products (fumes, discharge gases, heat, etc.).

**GENERATION IN AC (ALTERNATING CURRENT)**

Before each work session check the efficiency of the ground connection for the electricity-generating group if the distribution system adopted requires it, such as, for example, the TT and TN systems.

Check that the electrical specifications for the units to be powered - voltage, power, frequency - are compatible with those of the generator. Values that are too high or too low for voltage and frequency can damage electrical equipment irreparably. In some cases, for the powering of three-phase loads, it is necessary to ensure that the cyclic direction of the phases corresponds to the installation's requirements.

Connect the electric devices to be powered to the AC sockets, using suitable plugs and cables in prime condition.

Before starting up the group, make certain no dangerous situations exist on the installation to be powered.

Check that the thermal-magnetic switch (Z2) is in the OFF position (input lever in downward position).

Start up the electricity-generating group, positioning the thermal-magnetic switch (Z2) and differential switch (D) to ON (input lever in upward position).

Before powering on the utilities, check that the voltmeter (N) and frequency meter (E2) indicate nominal values; in addition, check on the voltmeter change-over switch (H2) (where it is assembled) that the three line voltages are the same.

⚠ In the absence of a load, the values for voltage and frequency can be greater than their nominal values. See sections on VOLTAGE and FREQUENCY.

**OPERATING CONDITIONS****POWER**

The electrical power expressed in kVA on an electricity-generating group is the available output power to the reference environmental conditions and nominal values for: voltage, frequency, power factors ( $\cos \varphi$ ).

There are various types of power: PRIME POWER (PRP), STAND-BY POWER established by ISO 8528-1 and 3046/1 Norms, and their definitions are listed in the manual's TECHNICAL SPECIFICATIONS page.

⚠ During the use of the electricity-generating group **NEVER EXCEED** the power indications, paying careful attention when several loads are powered simultaneously.

**VOLTAGE****GENERATORS WITH COMPOUND SETTING (THREEPHASE)****GENERATORS WITH CONDENSER SETTING (SINGLEPHASE)**

In these types of generators, the no-load voltage is generally greater than 3–5% with respect to its nominal value; f.e. for nominal voltage, threephase 400Vac or singlephase 230Vac, the no-load voltage can be comprised between 410-420V (threephase) and 235-245V (singlephase). The precision of the load voltage is maintained within  $\pm 5\%$  with balanced loads and with a rotation speed variation of 4%. Particularly, with resistive loads ( $\cos \varphi = 1$ ), a voltage over-elevation occurs which, with the machine cold and at full load, can even attain +10 %, a value which in any case is halved after the first 10-15 minutes of operation.

The insertion and release of the full load, under constant rotation speed, provokes a transitory voltage variation that is less than 10%; the voltage returns to its nominal value within 0.1 seconds.

**GENERATORS WITH ELECTRONIC SETTING (A.V.R.)**

In these types of generators, the voltage precision is maintained within  $\pm 1,5\%$ , with speed variations comprised from -10% to +30%, and with balanced loads. The voltage is the same both with no-load and with load; the insertion and release of the full load provokes a transitory voltage variation that is less than 15%; the voltage returns to its nominal value within 0.2–0.3 seconds.

**FREQUENCY**

The frequency is a parameter that is directly dependent on the motor's rotation speed. Depending on the type of alternator, 2 or 4 pole, we will have a frequency of 50/60 Hz with a rotation speed of 3000/3600 or 1500/1800 revolutions per minute.





The frequency, and therefore the number of motor revolutions, is maintained constant by the motor's speed regulation system. Generally, this regulator is of a mechanical type and presents a droop from no-load to nominal load which is less than 5 % (static or droop), while under static conditions precision is maintained within  $\pm 1\%$ . Therefore, for generators at 50Hz the no-load frequency can be 52–52.5 Hz, while for generators at 60Hz the no-load frequency can be 62.5–63Hz.

In some motors or for special requirements the speed regulator is electronic; in these cases, precision under static operating conditions attains  $\pm 0.25\%$ , and the frequency is maintained constant in operation from no-load to load (isochronal operation).

### **POWER FACTOR - COS $\varphi$**

The power factor is a value which depends on the load's electrical specifications; it indicates the ratio between the Active Power (kW) and Apparent Power (kVA). The apparent power is the total power necessary for the load, achieved from the sum of the active power supplied by the motor (after the alternator has transformed the mechanical power into electrical power), and the Reactive Power (kVAR) supplied by the alternator. The nominal value for the power factor is  $\cos \varphi = 0,8$ ; for different values comprised between 0.8 and 1 it is important during usage not to exceed the declared active power (kW), so as to not overload the electricity-generating group motor; the apparent power (kVA) will diminish proportionally to the increase of  $\cos \varphi$ . For  $\cos \varphi$  values of less than 0.8 the alternator must be downgraded, since at equal apparent power the alternator should supply a greater reactive power. For reduction coefficients, contact the Technical Service Department.

### **START-UP OF ASYNCHRONOUS MOTORS**

The start-up of asynchronous motors from an electricity-generating group can prove critical because of high start-up currents the asynchronous motor requires (I start-up = up to 8 times the nominal current  $I_n$ ). The start-up current must not exceed the alternator's admissible overload current for brief periods, generally in the order of 250–300% for 10–15 seconds. To avoid a group oversize, we recommend following these precautionary measures:

- in the case of a start-up of several motors, subdivide the motors into groups and set up their start-up at intervals of 30–60 seconds.
- when the operating machine coupled to the motor allows it, see to a start-up with reduced voltage, star point/triangle start-up or with autotransformer, or use a soft-start system.

In all cases, when the user circuit requires the start-up of an asynchronous motor, it is necessary to check that there are no utilities inserted into the installation, which in the case of a voltage droop can cause more or less serious disservices (opening of contact points, temporary lack of power to control and command systems, etc.).

### **SINGLE-PHASE LOADS**

Power to monophasic utilities by means of three-phase generators requires some operating limitations.

- In single-phase operation, the declared voltage tolerance can no longer be maintained by the regulator (compound or electronic regulator), since the system becomes highly unbalanced. **The voltage variation on the phases not affected by the power can prove dangerous; we recommend sectioning the other loads eventually connected.**
- The maximum power which can be drawn between Neutral and Phase (start connection) is generally 1/3 of the nominal three-phase power; some types of alternators even allow for 40%. Between two Phases (triangle connection) the maximum power cannot exceed 2/3 of the declared three-phase power.
- In electricity-generating groups equipped with monophasic sockets, use these sockets for connecting the loads. In other cases, always use the "R" phase and Neutral.

### **ELECTRIC PROTECTIONS**

#### **THERMAL-MAGNETIC SWITCH**

The electricity-generating group is protected against short-circuits and against overloads by a thermal-magnetic switch (Z2) situated upstream from the installation. Operating currents, both thermic and magnetic, can be fixed or adjustable in relation to the switch model.

In models with adjustable operating current **do not modify** the settings, since doing so can compromise the installation's protection or the electricity-generating group's output characteristics. For eventual variations, contact our Technical Service Department.

The intervention of the protection feature against overloads is not instantaneous, but follows a current overload/time outline; the greater the overload the less the intervention. Furthermore, keep in mind that the nominal operating current refers to an operating temperature of 30°C, so that each variation of 10°C roughly corresponds to a variation of 5% on the value of nominal current.

In case of an intervention on the part of the thermal magnetic protection device, check that the total absorption does not exceed the electricity-generating group's nominal current.

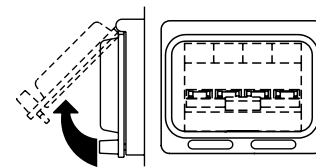
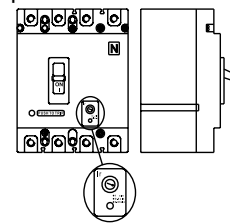

**DIFFERENTIAL SWITCH**

The differential switch or differential relay guarantee protection against indirect contacts due to malfunction currents towards the ground. When the device detects a malfunction current that is higher than the nominal current or the set current, it intervenes by cutting off power to the circuit connected.

In the case of an intervention by the differential switch, check that there are no sheathing defects in the installation: connection

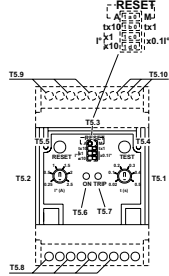
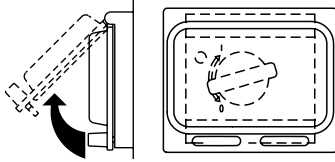

cables, sockets and plugs, utilities connected.

Before each work session, check the operation of the differential protection device by pressing the test key. The electricity-generating group must be in operation, and the lever on the differential switch must be in the ON position.

**THERMIC PROTECTION**

Generally present to protect against overloads on an individual power socket c.a.

When the nominal operating current has been exceeded, the protection device intervenes by cutting off power to the socket. The intervention of the protection device against overloads is not instantaneous, but follows a current overload/time outline; the greater the overload the less the intervention.

In case of an intervention, check that the current absorbed by the load does not exceed the protection's nominal operating current. Allow the protection to cool off for a few minutes before resetting by pressing the central pole.

**ATTENTION**

**Do not keep the central pole on the thermic protection forcefully pressed to prevent its intervention.**

**USAGE WITH EAS AUTOMATIC START-UP PANEL**

The electricity-generating group in combination with the EAS automatic start-up panel forms a unit for distributing electrical energy within a few seconds of a power failure from the commercial electrical power line.

Below is some general operating information; refer to the automatic panel's specific manual for details on installation, command, control and signalling operations.

- Perform connections on the installation in safety conditions. Position the automatic panel in RESET or LOCKED mode.
- Carry out the first start-up in MANUAL mode. Check that the generator's LOCAL START / REMOTE START switch (I6) is in the REMOTE position. Check that the generator switches are enabled (input lever in upward position). Position the EAS panel in manual mode by pressing MAN. key, and only after having checked that there are no dangerous situations, press the START key to start the electricity-generating group.
- During the operation of the generator, all controls and signals from both the automatic panel and group are enabled; it is therefore possible to control its operation from both positions.

In case of an alarm with a shutdown of the motor (low pressure, high temperature, etc.), the automatic panel will indicate the malfunction that has caused the stoppage, while the generator's front panel will be disabled and will no longer supply any information.





## NOTE

DO NOT INTERVENE ON THE SETTING OF THE PROTECTION SWITCH. BEFORE USING THE MACHINE CHECK THE ON WARNING LAMP LIGHTING.

### USE AS TROUBLE INDICATOR:

Placed on the front panel, the insulation monitor (A3) is a device which controls continuously the insulation of the generation a.c. circuits towards the ground.

### USE AS TROUBLE INDICATOR AND INTERVENTION:

The insulation monitor controls a device (release coil, contactor, etc.) which opens the whole circuit, lifting voltage in the whole part of the machine a.c. generation.

### USE OF SRI3/D2 MODEL:

- To change the setting, please call our Technical Assistance Department
  - The warning light ON shows that the device is powered.
  - By pressing a long time (5 seconds) the Test push-button, the ALARM and PRE-ALARM leds will light on, releasing it the PRE ALARM led goes off while the ALARM led remains lit. The pressure on the Reset key brings the device back to initial conditions.
  - If the insulation resistance goes down below the fixed PRE ALARM value, the PRE ALARM led will light up and switches the contact of PRE-ALARM.
- If the insulation resistance goes down furtherly and becomes inferior to the fixed value for the ALARM, the ALARM led lights and switches also the contact of ALARM relay.
- After having checked the device and removed the cause of the problem, re-establish the circuit pressing the push-button RESET.

### LEGEND:

1. Adjustment of Alarm threshold
2. Set-alarm dip-switches
3. Led, pre-allarm indication
4. Led , power indication
5. Led Alarm indication
6. Test push-button
7. Reset push-button
8. Adjustment of- PRE-ALARM threshold

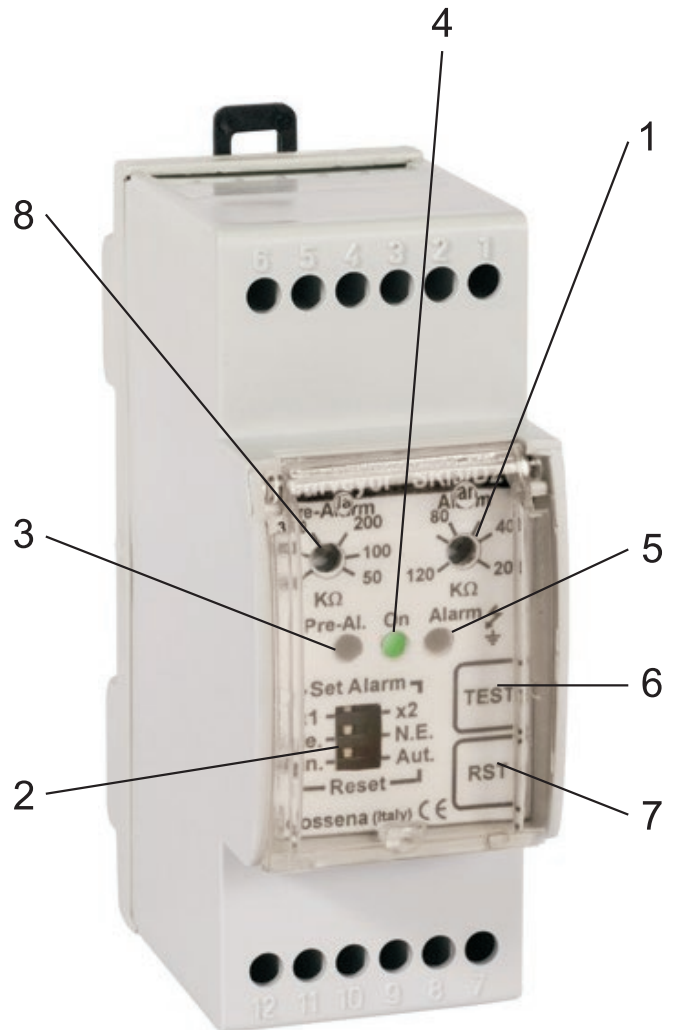



## MAKE SURE

When the TCM 15 - 6 is used, it is not possible to connect the E.A.S automatic intervention unit.

ENGLISH

### USE OF THE REMOTE CONTROL TCM 15

The coupling of the TCM 15 with the generating set, permits to work far from the set itself.

The remote control is connected to the front plate, with a multiple connector.

The TCM 15 assures the following functions:

- starting (starting key Q1)
- stop (starting key Q1)
- choke control (L6)

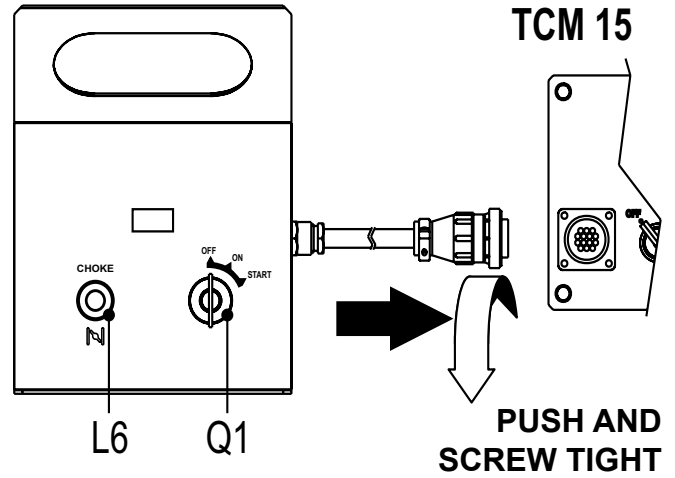

ENGLISH

### USE OF THE REMOTE CONTROL TCM 6

The coupling of the TCM 6 with the generating set, ready for remot starting, permits to work far from the set itself.

The remote control is connected to the front plate, and/or rear plate, with a multiple connector.

The TCM 6 assures the following functions:

- starting (starting key Q1)
- stop (starting key Q1)
- indication of oil low pressure (warning light O1)

To stop the set turn the key to the position "OFF".

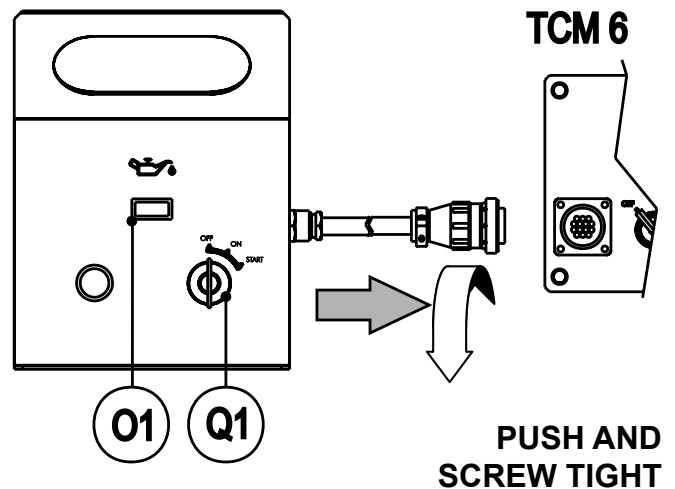



**N.B.:** the position of the selector LOCAL START/REMOTE START (I6) on the generating sets must be on the position "REMOTE START".

**WARNING**

- Have **qualified** personnel do maintenance and troubleshooting work.
- Stop the engine before doing any work inside the machine. If for any reason the machine must be operated while working inside, pay attention moving parts, hot parts (exhaust manifold and muffler, etc.) electrical parts which may be unprotected when the machine is open.
- Remove guards only when necessary to perform maintenance, and replace them when the maintenance requiring their removal is complete.
- Please wear the appropriate clothing and make use of the PPE (Personal Protective Equipment), according to the type of intervention (protective gloves, insulated gloves, glasses).
- Do not modify the components if not authorized. - See pag. M1.1 -

<b>Problem</b>	<b>Possible cause</b>	<b>Solution</b>
<b>PETROL ENGINE</b>		
The motor does not start up, or starts up and then stops immediately.	1) Key / engine switch in the wrong positions 2) Lack of or insufficient oil in the motor 3) Faulty motor stopping device (oil-alert) 4) Lack of fuel in tank or fuel tap closed 5) Fuel filter clogged 6) Bad gasoline. Gasoline oxidizes and deteriorates over time, causing hard starting 7) Dirty or faulty spark plug 8) Battery not activated, low or faulty 9) Battery cable terminals loose or corroded 10) Cold motor 11) Other causes	1) Verify start-up procedure 2) Refill or top off 3) Replace 4) Refill the tank. Open the fuel tap 5) Clean or replace 6) Drain fuel tank and carburetor. Refuel with fresh gasoline. 7) Clean or check and eventually replace 8) Activate, recharge, or replace the battery 9) Tighten and clean. Replace if corroded 10) Hold the command CHOKE, after starting, for a time longer 11) Consult the motor Operating Manual.
The motor does not accelerate. Inconstant speed. Too little power provided by motor.	1) Air or fuel filter clogged 2) Bad gasoline 3) Overload	1) Check the air filter 2) Drain fuel tank and carburetor. Refuel with fresh gasoline 3) Check the connected loads and if necessary reduce
Other problems or inconveniences on the engine.	Consult the motor Operating Manual	
<b>DIESEL ENGINE</b>		
The motor does not start up, or starts up and then stops immediately.	1) Lack of fuel in tank or fuel tap closed 2) Fuel filter clogged 3) Air leaks in fuel system 4) Battery not activated, low or faulty 5) Battery cable terminals loose or corroded 6) Faulty motor stopping device 7) Other causes	1) Refill the tank. Open the fuel tap 2) Replace 3) Check the feeding circuit 4) Activate, recharge, or replace the battery 5) Tighten and clean. Replace if corroded 6) Replace 7) Consult the motor Operating Manual.
The motor does not accelerate. Inconstant speed. Too little power provided by motor.	1) Air or fuel filter clogged 2) Overload	1) Clean or replace filter element(s) Consult the engine Operating Manual. 2) Check total load and eventually decrease
Other problems or inconveniences on the engine.	Consult the engine Operating Manual.	

GENERATOR		
Absence of output voltage	<ol style="list-style-type: none"> <li>1) Protection tripped due to overload</li> <li>2) Differential protection device tripped</li>   <li>3) Protection devices defective</li> <li>4) Alternator not excited</li>   <li>6) Faulty AVR</li> <li>7) AVR fuse faulty</li> </ol>	<ol style="list-style-type: none"> <li>1) Check the load connected and decrease</li> <li>2) Check the insulation of the whole system: wiring, connections, connected load and check that there are no insulation fault that cause leakage currents to earth</li> <li>3) Replace</li> <li>4) Carry out external excitation test as indicated in alternator manual. Ask for intervention of Service Department</li> <li>6) Replace</li> <li>7) Replace</li> </ol>
No-load output voltage too low or too high	<ol style="list-style-type: none"> <li>1) Incorrect engine running speed</li> <li>2) Alternator fault</li>   <li>3) AVR with setting wrong or fault</li> </ol>	<ol style="list-style-type: none"> <li>1) Regulate speed to its nominal no-load value</li> <li>2) Check winding, diodes, etc. on alternator (See to alternator manual). Repair or replace. Ask for intervention of Service Department.</li> <li>3) Adjust the Volt trimmer of AVR or replace</li> </ol>
Corrected no-load voltage too low with load	<ol style="list-style-type: none"> <li>1) Incorrect engine running speed due to overload</li> <li>2) Load with <math>\cos \varphi</math> less than the nominal one</li> <li>3) Alternator fault</li>   <li>4) Faulty AVR</li> </ol>	<ol style="list-style-type: none"> <li>1) Check the load connected and decrease</li> <li>2) Reduce or rephase load</li> <li>3) Check winding, diodes, etc. on alternator (See to alternator manual). Repair or replace. Ask for intervention of Service Department.</li> <li>4) Replace</li> </ol>
Unstable tension	<ol style="list-style-type: none"> <li>1) Contacts malfunctioning</li> <li>2) irregular engine revolution</li> <li>3) Alternator fault</li> </ol>	<ol style="list-style-type: none"> <li>1) Check electrical connections and tighten</li> <li>2) Ask for intervention of Service Department</li> <li>3) Check winding, diodes, etc. on alternator (See to alternator manual). Repair or replace. Ask for intervention of Service Department.</li> </ol>

 <b>WARNING</b>		
	<ul style="list-style-type: none"> <li>• Have <b>qualified</b> personnel do maintenance and troubleshooting work.</li> <li>• Stop the engine before doing any work inside the machine. If for any reason the machine must be operated while working inside, <b>pay attention</b> moving parts, hot parts (exhaust manifold and muffler, etc.) electrical parts which may be unprotected when the machine is open.</li> <li>• Remove guards only when necessary to perform maintenance, and replace them when the maintenance requiring their removal is complete.</li> <li>• Please wear the appropriate clothing and make use of the PPE (Personal Protective Equipment), according to the type of intervention (protective gloves, insulated gloves, glasses).</li> <li>• Do not modify the components if not authorized.</li> </ul> <p>- See pag. M1.1 -</p>	
<b>MOVING PARTS</b> can injure		<b>HOT surface</b> can hurt you

**NOTE**

By maintenance at care of the utilizer we intend all the operatios concerning the verification of mechanical parts, electrical parts and of the fluids subject to use or consumption during the normal operation of the machine.

For what concerns the fluids we must consider as maintenance even the periodical change and or the refills eventually necessary.

Maintenance operations also include machine cleaning operations when carried out on a periodic basis outside of the normal work cycle.

The repairs **cannot be considered** among the maintenance activities, i.e. the replacement of parts subject to occasional damages and the replacement of electric and mechanic components consumed in normal use, by the Assistance Authorized Center as well as by manufacturer.

The replacement of tires (for machines equipped with trolleys) must be considered as repair since it is not delivered as standard equipment any lifting system.

The periodic maintenance should be performed according to the schedule shown in the engine manual. An optional hour counter (M) is available to simplify the determination of the working hours.

**VENTILATION**

Make certain there are no obstructions (rags, leaves or other) in the air inlet and outlet openings on the machine, alternator and motor.

**ELECTRICAL PANELS**

Check condition of cables and connections daily. Clean periodically using a vacuum cleaner, **DO NOT USE COMPRESSED AIR.**

**DECALS AND LABELS**

*All warning and decals should be checked once a year and **replaced** if missing or unreadable.*

**STRENUOUS OPERATING CONDITIONS**



Under extreme operating conditions (frequent stops and starts, dusty environment, cold weather, extended periods of no load operation, fuel with over 0.5% sulphur content) do maintenance more frequently.

**BATTERY WITHOUT MAINTENANCE  
DO NOT OPEN THE BATTERY**

The battery is charged automatically from the battery charger circuit supplied with the engine.

Check the state of the battery from the colour of the warning light which is in the upper part.

- Green colour: battery OK
- Black colour: battery to be recharged
- White colour: battery to be replaced

 <b>IMPORTANT</b>
 <p>In the maintenance operations avoid that polluting substances, liquids, exhausted oils, etc. bring damage to people or things or can cause negative effects to surroundings, health or safety respecting completely the laws and/or dispositions in force in the place.</p>

**ENGINE AND ALTERNATOR**

**PLEASE REFER TO THE SPECIFIC MANUALS PROVIDED.**

Every engine and alternator manufacturer has maintenance intervals and specific checks for each model: it is necessary to consult the specific engine or alternator USER AND MAINTENANCE manual.

 <b>NOTE</b>
<p>THE ENGINE PROTECTION NOT WORK WHEN THE OIL IS OF LOW QUALITY BECAUSE NOT CHARGED REGULARLY AT INTERVALS AS PRESCRIBED IN THE OWNER'S ENGINE MANUAL.</p>





## ATTENTION

- Maintenance operations on the electricity-generating group prearranged for automatic operation must be carried out with the panel in RESET mode.
- Maintenance operations on the installation's electrical panels must be carried out in complete safety by cutting off all external power sources: ELECTRICAL POWER, GROUP and BATTERY.

For the electricity-generating groups prearranged for automatic operation, in addition to carrying out all periodic maintenance operations foreseen for normal usage, various operations must be carried out that are necessary in relation to the specific type of use. The electricity-generating group in fact must be continuously prepared for operation, even after prolonged periods of inactivity.

### MAINTENANCE GENERATING SET WITH AUTOMATIC BOARD

	EVERY WEEK	EVERY MONTH AND/OR AFTER INTERVENTION ON LOAD	EVERY YEAR
1. TEST or AUTOMATIC TEST cycle to keep the generating set constantly operative	NO-LOAD X	WITH LOAD X	
2. Check all levels: engine oil, fuel level, battery electrolyte., if necessary top it up.	X	X	
3. Control of electrical connections and cleaning of control panel		X	X

- **Carry out motor oil change at least once a year, even if the requested number of hours has not been attained.**



**STORAGE**

In case the machine should not be used for more than 30 days, make sure that the room in which it is stored presents a suitable shelter from heat sources, weather changes or anything which can cause rust, corrosion or damages to the machine.

☛ Have **qualified** personnel prepare the machine for storage.

**GASOLINE ENGINE**

Start the engine: It will run until it stops due to the lack of fuel.

Drain the oil from the engine sump and fill it with new oil (see page M25).

Pour about 10 cc of oil into the spark plug hole and screw the spark plug, after having rotated the crankshaft several times.

Rotate the crankshaft slowly until you feel a certain compression, then leave it.

In case the battery, for the electric start, is assembled, disconnect it.

Clean the covers and all the other parts of the machine carefully.

Protect the machine with a plastic hood and store it in a dry place.

**DIESEL ENGINE**

For short periods of time it is advisable, about every 10 days, to make the machine work with load for 15-30 minutes, for a correct distribution of the lubricant, to recharge the battery and to prevent any possible blocking of the injection system.

For long periods of inactivity, turn to the after sales service of the engine manufacturer.

Clean the covers and all the other parts of the machine carefully.

Protect the machine with a plastic hood and store it in a dry place.

**IMPORTANT**

In the storage and cust off operations avoid that polluting substances, liquids, exhausted oils, etc. bring damage to people or things or can cause negative effects to surroundings, health or safety respecting completely the laws and/or dispositions in force in the place.

**DISASSEMBLE**

☛ Have **qualified** personnel disassemble the machine and dispose of the parts, including the oil, fuel, etc., in a correct manner when it is to be taken out of service.

As disassemble we intend all operations to be made, at utilizer's care, at the end of the use of the machine.

This comprises the dismantling of the machine, the subdivision of the several components for a further reutilization or for getting rid of them, the eventual packing and transportation of the eliminated parts up to their delivery to the store, or to the bureau entrusted to the disassemble or to the storage office, etc.

The several operations concerning the disassemble, involve the manipulation of fluids potentially dangerous such as: lubricating oil and battery electrolyte.

The dismantling of metallic parts liable to cause injuries or wounds, must be made wearing heavy gloves and using suitable tools.

The getting rid of the various components of the machine must be made accordingly to rules in force of law a/o local rules.

**Particular attention must be paid when getting rid of: lubricating oils, battery electrolyte, and inflammable liquids such as fuel, cooling liquid.**

The machine user is responsible for the observance of the norms concerning the environment conditions with regard to the elimination of the machine being disassemble and of all its components.

In case the machine should be disassemble without any previous disassembly it is however compulsory to remove:

- tank fuel
- engine lubricating oil
- cooling liquid from the engine
- battery

**NOTE:** The manufacturer is involved with disassembling the machine **only** for the second hand ones, when not reparable.

This, of course, after authorization.

In case of necessity for first aid and fire prevention, see page M2.1.



GENERATOR		GE S-6000 YDM	GE S-6000 YDM AVR
*Stand-by single-phase power		5.7 kVA (5.1 kW) / 230 V / 24.8 A	
*PRP single-phase power		5 kVA (4.5 kW) / 230 V / 21.7 A	
Frequency		50 Hz	
Cos φ		0.9	
<i>* Output powers according to ISO 8528-1</i>			
ALTERNATOR		Self-excited, Self-regulated, Brushless	Self-excited, Self-regulated
Type		Single-phase, Synchronous	
Insulation class		H	
ENGINE			
Make / Model		YANMAR L 100	
Type / Cooling system		Diesel 4-Stroke / Air	
Cylinder / Displacement		1 / 435 cm <sup>3</sup>	
*Stand by net power		6.3 kW (8.5 HP)	
*PRP net power		5.7 kW (7.7 HP)	
Speed		3000 rpm	
Fuel consumption (75% of PRP)		1 l/h	
Engine oil capacity (max)		1.6 l	
Starter		Recoil / Electric	
<i>* Powers according to SAE J1349</i>			
GENERAL SPECIFICATIONS			
Battery charge		12 Vdc -18Ah (AE)	
Tank capacity		20 l	
Running time (75% of PRP)		20 h	
Protection		IP 23	
*Dimensions max. on base LxIxh (mm)		770x520x650	
*Weight (dry)	123 kg (AA) - 133 kg (AE)	127 kg (AVR – AA) - 137 kg (AVR – AE)	
Acoustic power LwA (pression LpA)		99 dB(A) (74 dB(A) @ 7 m)	
<i>* Dimensions and weight without trolley/trailer.</i>			

**OUTPUT**

Declared power according to ISO 8528-1 (temperature 25°C, 30% relative humidity, altitude 100 m above sea level).

(\*Stand-by) = maximum available power for use at variable loads for a yearly number of hours limited at 500 h. No overload is admitted.

(\*\*Prime power PRP) = maximum available power for use at variable loads for a yearly illimited number of hours. The average power to be taken during a period of 24 h must not be over 80% of the PRP.

It's admitted overload of 10% each hour every 12 h.

In an approximative way one reduces: of 1% every 100 m altitude and of 2.5% for every 5°C above 25°C.

**ACOUSTIC POWER LEVEL**

**ATTENTION:** The concrete risk due to the machine depends on the conditions in which it is used. Therefore, it is up to the end-user and under his direct responsibility to make a correct evaluation of the same risk and to adopt specific precautions (for instance, adopting a I.P.D. -Individual Protection Device)

**Acoustic Noise Level (LwA) - Measure Unit dB(A):** it stands for acoustic noise released in a certain delay of time. This is not submitted to the distance of measurement.

**Acoustic Pressure (Lp) - Measure Unit dB(A):** it measures the pressure originated by sound waves emission. Its value changes in proportion to the distance of measurement.

The here below table shows examples of acoustic pressure (Lp) at different distances from a machine with Acoustic Noise Level (LwA) of 95 dB(A)

Lp a 1 meter = 95 dB(A) - 8 dB(A) = 87 dB(A)

Lp a 7 meters = 95 dB(A) - 25 dB(A) = 70 dB(A)

Lp a 4 meters = 95 dB(A) - 20 dB(A) = 75 dB(A)

Lp a 10 meters = 95 dB(A) - 28 dB(A) = 67 dB(A)

**PLEASE NOTE:** the symbol  when with acoustic noise values, indicates that the device respects noise emission limits according to 2000/14/CE directive.

GENERATOR		GE S-6500 YDT	GE S-6500 YDT AVR
*Stand-by three-phase power		6.5 kVA (5.2 kW) / 400V / 9.4 A	
*PRP three-phase power		5.7 kVA (4.6 kW) / 400V / 8.2 A	
*PRP single-phase power		4 kVA / 230V / 17.4 A	
Frequency		50 Hz	
Cos φ		0.8	
<i>* Output powers according to ISO 8528-1</i>			
ALTERNATOR		Self-excited, Self-regulated	
Type		Three-phase, Synchronous	
Insulation class		H	
ENGINE			
Make / Model		YANMAR L 100	
Type / Cooling system		Diesel 4-Stroke / Air	
Cylinder / Displacement		1 / 435 cm <sup>3</sup>	
*Stand by net power		6.3 kW (8.5 HP)	
*PRP net power		5.7 kW (7.7 HP)	
Speed		3000 rpm	
Fuel consumption (75% of PRP)		1 l/h	
Engine oil capacity (max)		1.6 l	
Starter		Recoil / Electric	
<i>* Powers according to SAE J1349</i>			
GENERAL SPECIFICATIONS			
Battery charge		12 Vdc -18Ah (AE)	
Tank capacity		20 l	
Running time (75% of PRP)		20 h	
Protection		IP 23	
*Dimensions max. on base LxIxh (mm)		770x520x650	
*Weight (dry)		127 kg (AA) - 137 kg (AE)	131 kg (AVR – AA) - 141 kg (AVR – AE)
Acoustic power LwA (pression LpA)		99 dB(A) (74 dB(A) @ 7 m)	
<i>* Dimensions and weight without trolley/trailer.</i>			

**OUTPUT**

Declared power according to ISO 8528-1 (temperature 25°C, 30% relative humidity, altitude 100 m above sea level).

(\*Stand-by) = maximum available power for use at variable loads for a yearly number of hours limited at 500 h. No overload is admitted.

(\*\*Prime power PRP) = maximum available power for use at variable loads for a yearly illimited number of hours. The average power to be taken during a period of 24 h must not be over 80% of the PRP.

It's admitted overload of 10% each hour every 12 h.

In an approximative way one reduces: of 1% every 100 m altitude and of 2.5% for every 5°C above 25°C.

**ACOUSTIC POWER LEVEL**

**ATTENTION:** The concrete risk due to the machine depends on the conditions in which it is used. Therefore, it is up to the end-user and under his direct responsibility to make a correct evaluation of the same risk and to adopt specific precautions (for instance, adopting a I.P.D. -Individual Protection Device)

**Acoustic Noise Level (LwA) - Measure Unit dB(A):** it stands for acoustic noise released in a certain delay of time. This is not submitted to the distance of measurement.

**Acoustic Pressure (Lp) - Measure Unit dB(A):** it measures the pressure originated by sound waves emission. Its value changes in proportion to the distance of measurement.

The here below table shows examples of acoustic pressure (Lp) at different distances from a machine with Acoustic Noise Level (LwA) of 95 dB(A)

Lp a 1 meter = 95 dB(A) - 8 dB(A) = 87 dB(A)

Lp a 4 meters = 95 dB(A) - 20 dB(A) = 75 dB(A)

Lp a 7 meters = 95 dB(A) - 25 dB(A) = 70 dB(A)

Lp a 10 meters = 95 dB(A) - 28 dB(A) = 67 dB(A)

**PLEASE NOTE:** the symbol  when with acoustic noise values, indicates that the device respects noise emission limits according to 2000/14/CE directive.

<b>GENERATOR</b>		<b>GE S-6500 YDT (IP54)</b>
*Stand-by three-phase power	7 kVA (5.4 kW) / 400V / 10 A	
*PRP three-phase power	6 kVA (4.8 kW) / 400V / 8.7 A	
*PRP single-phase power	5 kVA / 230V / 21.7 A	
Frequency	50 Hz	
Cos φ	0.8	
<i>* Output powers according to ISO 8528-1</i>		
<b>ALTERNATOR</b>		<b>Self-excited, Self-regulated</b>
Type	Three-phase, Synchronous	
Insulation class	H	
<b>ENGINE</b>		
Make / Model	YANMAR L 100	
Type / Cooling system	Diesel 4-Stroke / Air	
Cylinder / Displacement	1 / 435 cm <sup>3</sup>	
*Stand by net power	6.3 kW (8.5 HP)	
*PRP net power	5.7 kW (7.7 HP)	
Speed	3000 rpm	
Fuel consumption (75% of PRP)	1 l/h	
Engine oil capacity (max)	1.6 l	
Starter	Recoil / Electric	
<i>* Powers according to SAE J1349</i>		
<b>GENERAL SPECIFICATIONS</b>		
Battery charge	12 Vdc -18Ah (AE)	
Tank capacity	20 l	
Running time (75% of PRP)	20 h	
Protection	IP54	
*Dimensions max. on base LxIhx (mm)	770x520x650	
*Weight (dry)	141 kg	
Acoustic power LwA (pression LpA)	99 dB(A) (74 dB(A) @ 7 m)	
<i>* Dimensions and weight without trolley/trailer.</i>		

**OUTPUT**

Declared power according to ISO 8528-1 (temperature 25°C, 30% relative humidity, altitude 100 m above sea level).

(\*Stand-by) = maximum available power for use at variable loads for a yearly number of hours limited at 500 h. No overload is admitted.

(\*\*Prime power PRP) = maximum available power for use at variable loads for a yearly illimited number of hours. The average power to be taken during a period of 24 h must not be over 80% of the PRP.

It's admitted overload of 10% each hour every 12 h.

In an approximative way one reduces: of 1% every 100 m altitude and of 2.5% for every 5°C above 25°C.

**ACOUSTIC POWER LEVEL**

**ATTENTION:** The concrete risk due to the machine depends on the conditions in which it is used. Therefore, it is up to the end-user and under his direct responsibility to make a correct evaluation of the same risk and to adopt specific precautions (for instance, adopting a I.P.D. -Individual Protection Device)

**Acoustic Noise Level (LwA) - Measure Unit dB(A):** it stands for acoustic noise released in a certain delay of time. This is not submitted to the distance of measurement.

**Acoustic Pressure (Lp) - Measure Unit dB(A):** it measures the pressure originated by sound waves emission. Its value changes in proportion to the distance of measurement.

The here below table shows examples of acoustic pressure (Lp) at different distances from a machine with Acoustic Noise Level (LwA) of 95 dB(A)

Lp a 1 meter = 95 dB(A) - 8 dB(A) = 87 dB(A)

Lp a 7 meters = 95 dB(A) - 25 dB(A) = 70 dB(A)

Lp a 4 meters = 95 dB(A) - 20 dB(A) = 75 dB(A)

Lp a 10 meters = 95 dB(A) - 28 dB(A) = 67 dB(A)

**PLEASE NOTE:** the symbol  when with acoustic noise values, indicates that the device respects noise emission limits according to 2000/14/CE directive.

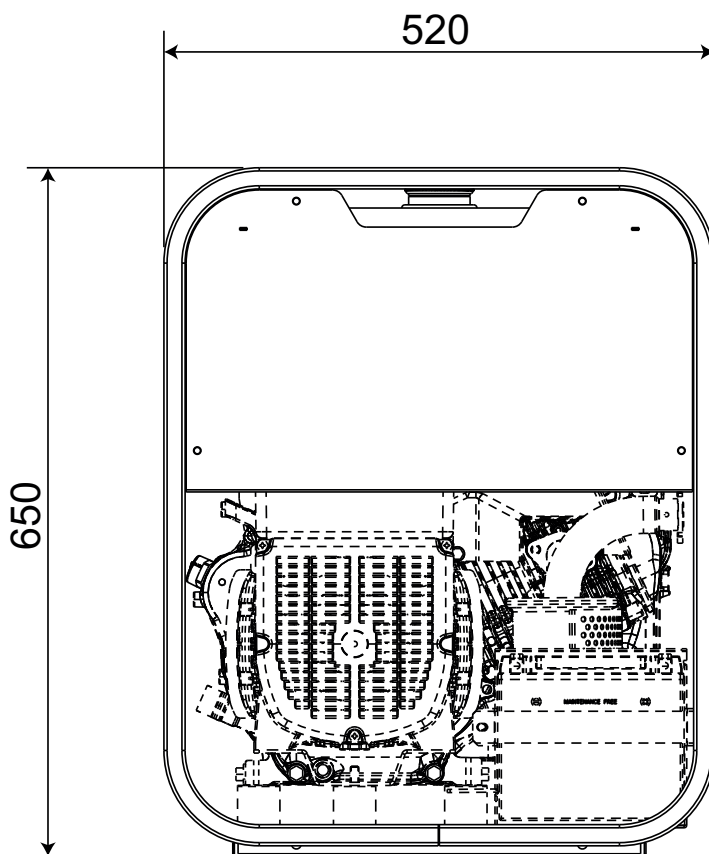
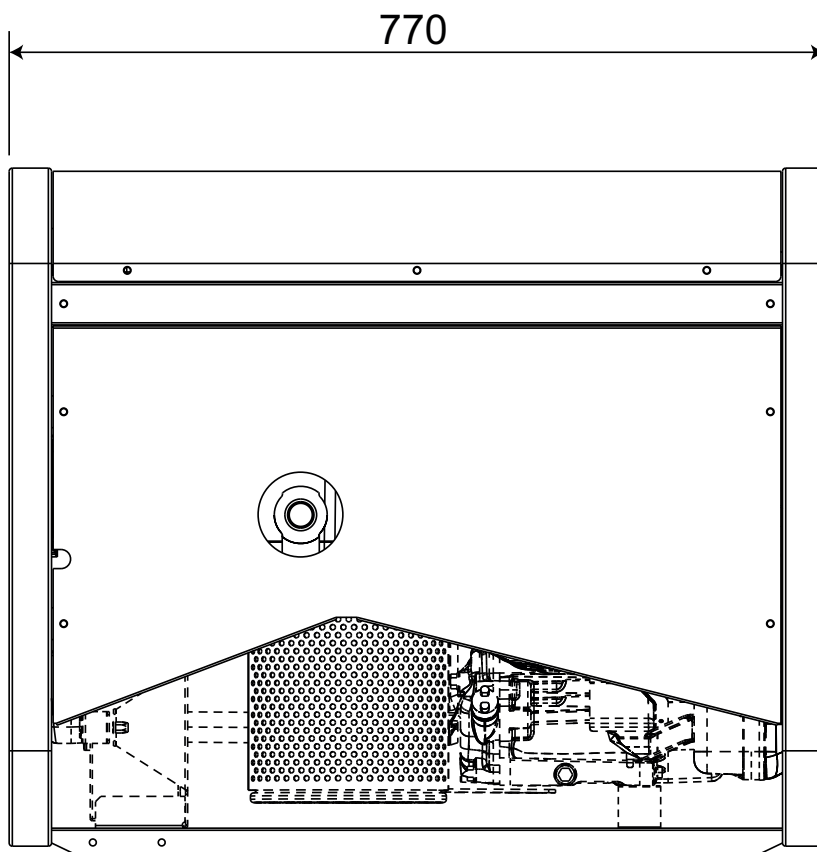

A : Alternator	E3 : Open circuit voltage switch	I6 : Start Local/Remote selector	N9 : UP/DOWN button mast
B : Wire connection unit	F3 : Stop push-button	L6 : Choke button	O9 : Hydraulic unit solenoid valve
C : Capacitor	G3 : Ignition coil	M6 : Switch CC/CV	P9 : Hydraulic unit engine
D : G.F.I.	H3 : Spark plug	N6 : Connector – wire feeder	Q9 : Ignitor
E : Welding PCB transformer	I3 : Range switch	O6 : 420V/110V 3-phase transformer	R9 : Lamp
F : Fuse	L3 : Oil shut-down button	P6 : Switch IDLE/RUN	S9 : Power system
G : 400V 3-phase socket	M3 : Battery charge diode	Q6 : Hz/V/A analogic instrument	T9 : 48Vdc power system
H : 230V 1phase socket	N3 : Relay	R6 : EMC filter	U9 : LED projector
I : 110V 1-phase socket	O3 : Resistor	S6 : Wire feeder supply switch	V9 : 125/250V 1phase socket
L : Socket warning light	P3 : Sparkler reactor	T6 : Wire feeder socket	Z9 : AMF25 generating set test
M : Hour-counter	Q3 : Output power unit	U6 : DSP chopper PCB	W9 : Multifunction LED instrument
N : Voltmeter	R3 : Electric siren	V6 : Power chopper supply PCB	X9 : InteliNano generating set test
P : Welding arc regulator	S3 : E.P.4 engine protection	Z6 : Switch and leds PCB	Y9 :
Q : 230V 3-phase socket	T3 : Engine control PCB	W6 : Hall sensor	
R : Welding control PCB	U3 : R.P.M. electronic regulator	X6 : Water heater indicator	
S : Welding current ammeter	V3 : PTO HI control PCB	Y6 : Battery charge indicator	
T : Welding current regulator	Z3 : PTO HI 20 l/min push-button	A7 : Transfer pump selector AUT-0-MAN	
U : Current transformer	W3 : PTO HI 30 l/min push-button	B7 : Fuel transfer pump	
V : Welding voltage voltmeter	X3 : PTO HI reset push-button	C7 : "GECO" generating set test	
Z : Welding sockets	Y3 : PTO HI 20 l/min indicator	D7 : Flooting with level switches	
X : Shunt	A4 : PTO HI 30 l/min indicator	E7 : Voltmeter regulator	
W : D.C. inductor	B4 : PTO HI reset indicator	F7 : WELD/AUX switch	
Y : Welding diode bridge	C4 : PTO HI 20 l/min solenoid valve	G7 : Reactor, 3-phase	
A1 : Arc striking resistor	D4 : PTO HI 30 l/min solenoid valve	H7 : Switch disconnecter	
B1 : Arc striking circuit	E4 : Hydraulic oil pressure switch	I7 : Solenoid stop timer	
C1 : 110V D.C./48V D.C. diode bridge	F4 : Hydraulic oil level gauge	L7 : "VODIA" connector	
D1 : E.P.1 engine protection	G4 : Preheating glow plugs	M7 : "F" EDC4 connector	
E1 : Engine stop solenoid	H4 : Preheating gearbox	N7 : OFF-ON-DIAGN. selector	
F1 : Acceleration solenoid	I4 : Preheating indicator	O7 : DIAGNOSTIC push-button	
G1 : Fuel level transmitter	L4 : R.C. filter	P7 : DIAGNOSTIC indicator	
H1 : Oil or water thermostat	M4 : Heater with thermostat	Q7 : Welding selector mode	
I1 : 48V D.C. socket	N4 : Choke solenoid	R7 : VRD load	
L1 : Oil pressure switch	O4 : Step relay	S7 : 230V 1-phase plug	
M1 : Fuel warning light	P4 : Circuit breaker	T7 : V/Hz analogic instrument	
N1 : Battery charge warning light	Q4 : Battery charge sockets	U7 : Engine protection EP6	
O1 : Oil pressure warning light	R4 : Sensor, cooling liquid temperature	V7 : G.F.I. relay supply switch	
P1 : Fuse	S4 : Sensor, air filter clogging	Z7 : Radio remote control receiver	
Q1 : Starter key	T4 : Warning light, air filter clogging	W7 : Radio remote control transmitter	
R1 : Starter motor	U4 : Polarity inverter remote control	X7 : Isometer test push-button	
S1 : Battery	V4 : Polarity inverter switch	Y7 : Remote start socket	
T1 : Battery charge alternator	Z4 : Transformer 230/48V	A8 : Transfer fuel pump control	
U1 : Battery charge voltage regulator	W4 : Diode bridge, polarity change	B8 : Ammeter selector switch	
V1 : Solenoid valve control PCB	X4 : Base current diode bridge	C8 : 400V/230V/115V commutator	
Z1 : Solenoid valve	Y4 : PCB control unit, polarity inverter	D8 : 50/60 Hz switch	
W1 : Remote control switch	A5 : Base current switch	E8 : Cold start advance with temp. switch	
X1 : Remote control and/or wire feeder socket	B5 : Auxiliary push-button ON/OFF	F8 : START/STOP switch	
Y1 : Remote control plug	C5 : Accelerator electronic control	G8 : Polarity inverter two way switch	
A2 : Remote control welding regulator	D5 : Actuator	H8 : Engine protection EP7	
B2 : E.P.2 engine protection	E5 : Pick-up	I8 : AUTOIDLE switch	
C2 : Fuel level gauge	F5 : Warning light, high temperature	L8 : AUTOIDLE PCB	
D2 : Ammeter	G5 : Commutator auxiliary power	M8 : A4E2 ECM engine PCB	
E2 : Frequency meter	H5 : 24V diode bridge	N8 : Remote emergency stop connector	
F2 : Battery charge transformer	I5 : Y/▲ commutator	O8 : V/A digital instruments and led VRD PCB	
G2 : Battery charge PCB	L5 : Emergency stop button	P8 : Water in fuel	
H2 : Voltage selector switch	M5 : Engine protection EP5	Q8 : Battery disconnect switch	
I2 : 48V a.c. socket	N5 : Pre-heat push-button	R8 : Inverter	
L2 : Thermal relay	O5 : Accelerator solenoid PCB	S8 : Overload led	
M2 : Contactor	P5 : Oil pressure switch	T8 : Main IT/TN selector	
N2 : G.F.I. and circuit breaker	Q5 : Water temperature switch	U8 : NATO socket 12V	
O2 : 42V EEC socket	R5 : Water heater	V8 : Diesel pressure switch	
P2 : G.F.I. resistor	S5 : Engine connector 24 poles	Z8 : Remote control PCB	
Q2 : T.E.P. engine protection	T5 : Electronic GFI relais	W8 : Pressure turbo protection	
R2 : Solenoid control PCB	U5 : Release coil, circuit breaker	X8 : Water in fuel sender	
S2 : Oil level transmitter	V5 : Oil pressure indicator	Y8 : EDC7-UC31 engine PCB	
T2 : Engine stop push-button T.C.1	Z5 : Water temperature indicator	A9 : Low water level sender	
U2 : Engine start push-button T.C.1	W5 : Battery voltmeter	B9 : Interface card	
V2 : 24V c.a. socket	X5 : Contactor, polarity change	C9 : Limit switch	
Z2 : Thermal magnetic circuit breaker	Y5 : Voltage switch	D9 : Starter timing card	
W2 : S.C.R. protection unit	A6 : Commutator/switch	E9 : Luquid pouring level float	
X2 : Remote control socket	B6 : Control panel power switch	F9 : Under voltage coil	
Y2 : Remote control plug	C6 : QEA control unit	G9 : Low water level warning light	
A3 : Insulation moiting	D6 : Connector, PAC	H9 : Chopper driver PCB	
B3 : E.A.S. connector	E6 : Frequency rpm regulator	I9 : Fuel filter heater	
C3 : E.A.S. PCB	F6 : Arc-Force selector	L9 : Air heater	
D3 : Booster socket	G6 : Device starting motor	M9 : ON/OFF switch lamp	
	H6 : Fuel electro pump 12V c.c.		

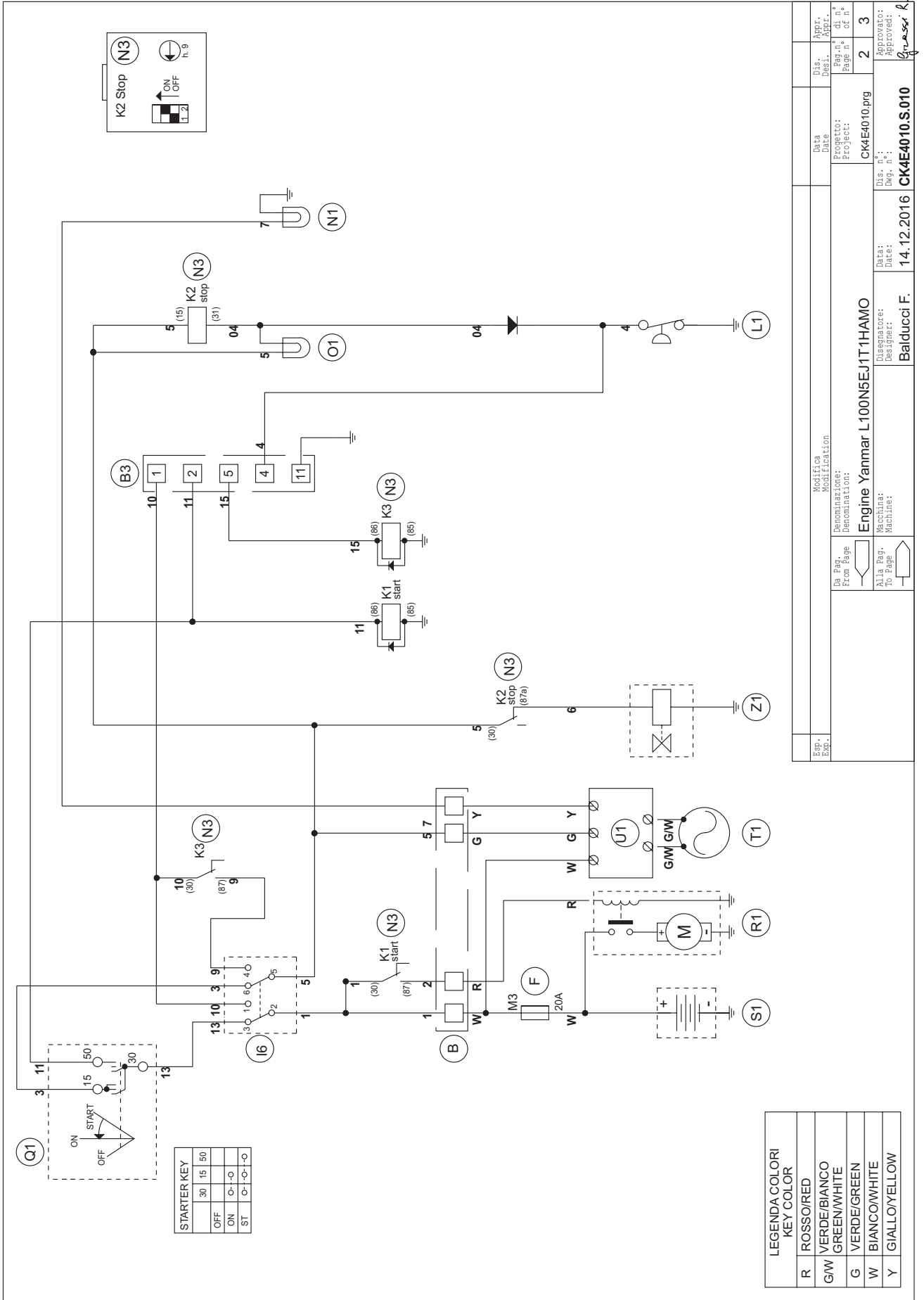

STARTER KEY	
30	15 50
OFF	ON
ON	OFF
ST	OFF

LEGENDA COLORI KEY COLOR	
R	ROSSO/RED
G/W	VERDE/BIANCO GREEN/WHITE
G	VERDE/GREEN
W	BIANCO/WHITE
Y	GIALLO/YELLOW

Modifica Modification		Data Date	
Dis. n° Page n°	Appr. Appr.	Dis. n° Page n°	Appr. Appr.
Progetto: Project:	CK4E4010.prg	Dis. n° Page n°	2 3
Denominazione: Denomination:	Engine Yanmar L100N5EJ1THAMO	Disegnatore: Designer:	Balducci F.
Da Pag. From Page		Data: Date:	14.12.2016
Alla Pag. To Page		Disegnatura: Machine:	CK4E4010.S.010
		Approvato: Approved:	Grassi R.

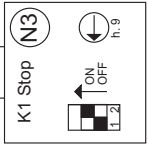
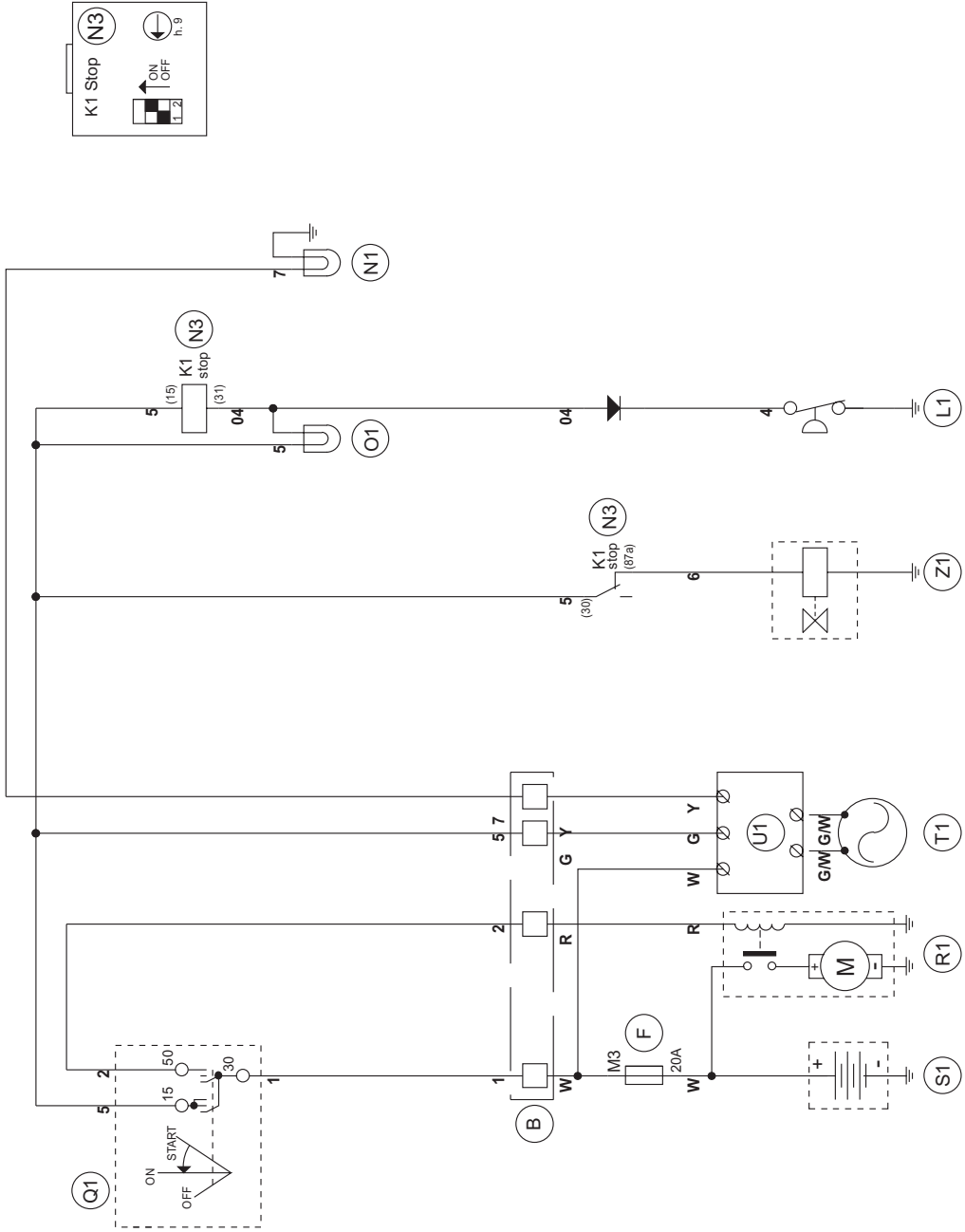

STARTER KEY	
30	15 50
OFF	ON
ON	OFF
ST	STOP

LEGENDA COLORI KEY COLOR	
R	ROSSO/RED
G/W	VERDE/BIANCO GREEN/WHITE
G	VERDE/GREEN
W	BIANCO/WHITE
Y	GIALLO/YELLOW

Esp. Exp.		Modifica Modification		Data Date		Dis. Desi. Dis. Desi.		Appr. Appr.	
Da Par. From Page	Denominazione: Engine Yanmar L100N5EJ1THAMO (vers. ISOMETER)	Progetto: CK4E4010.prg	Dis. n°: 1	Appr. n°: 2	Dis. n°: 1	Appr. n°: 2	Dis. n°: 1	Appr. n°: 2	Dis. n°: 1
Da Alla Par. To Page	Macchina: Balducci F.	Disegnatore: Balducci F.	Dis. n°: 23.01.2017	Dis. n°: CK5E-4010.S.010	Dis. n°: 1	Appr. n°: 2	Dis. n°: 1	Appr. n°: 2	Dis. n°: 1



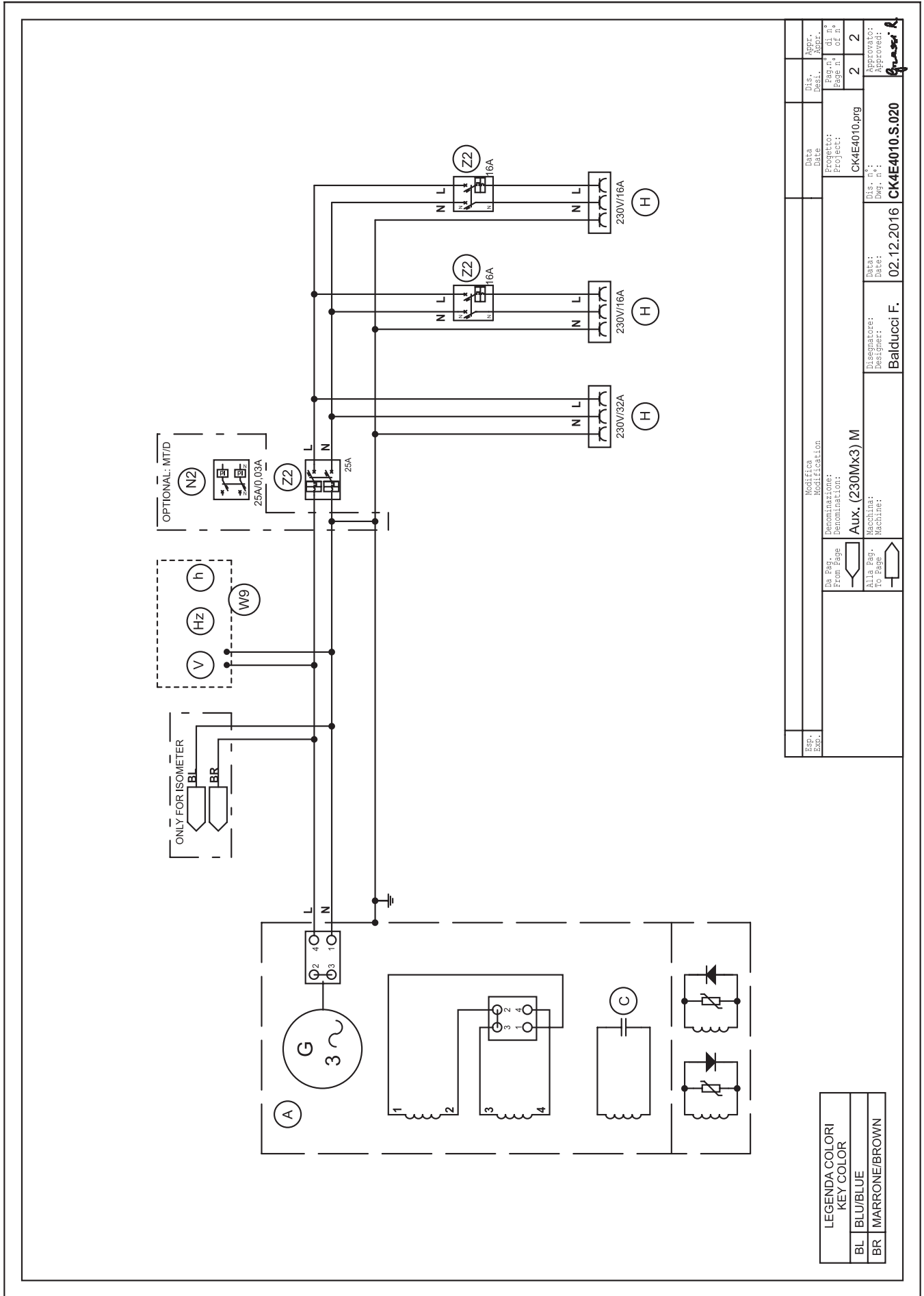

Esp. Esp.	Modifica Modification	Data Date	Appr. Appr.
Da Pag. From Page	Denominazione: Project:	CK4E4010.prg	Pag. n. di n. Page n. of n.
Alia Pag. To Page	Aux. (230Mx3) M	Dis. n. Dwg. n.:	2 2
	Macchina: Machine:	Balducci F.	02.12.2016
		CK4E4010.S.020	Approvato: Approved: <i>Balducci F.</i>

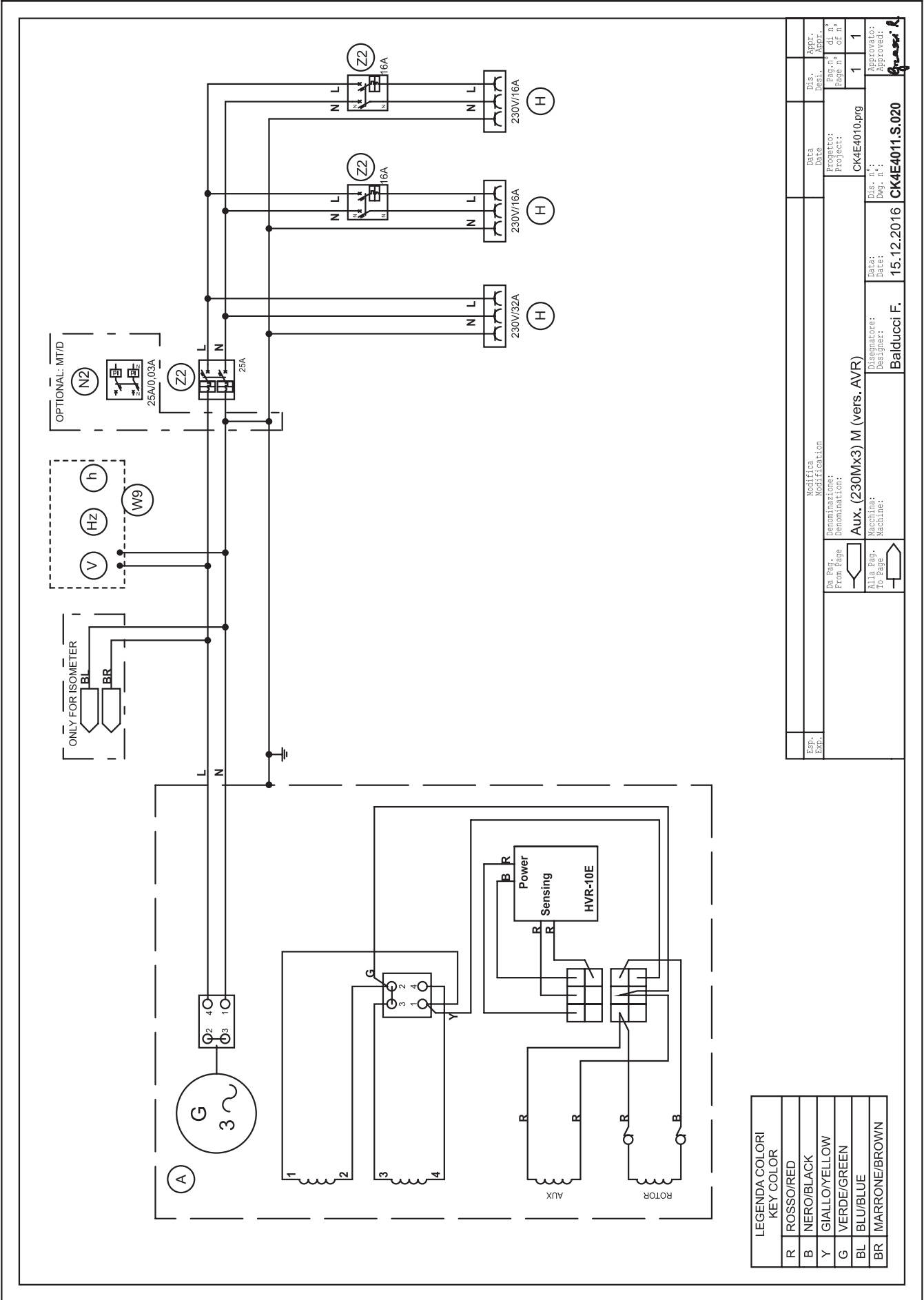

LEGENDA COLORI KEY COLOR
R ROSSO/RED
B NERO/BLACK
Y GIALLO/YELLOW
G VERDE/GREEN
BL BLU/BLUE
BR MARRONE/BROWN

Exp. / Modifica	Data / Date	Dis. / Des.	Appr. / Appr.
Da Pag. / From Page	Progetto: / Project:	Dis. / Des.	Appr. / Appr.
Alla Pag. / To Page	Denominazione: / Denomination:	Dis. / Des.	Appr. / Appr.
	Aux. (230Mx3) M (vers. AVR)	Dis. / Des.	Appr. / Appr.
	Macchina: / Machine:	Dis. / Des.	Appr. / Appr.
	Disegnato: / Designer:	Dis. / Des.	Appr. / Appr.
	Balducci F.	Dis. / Des.	Appr. / Appr.
	15.12.2016	Dis. / Des.	Appr. / Appr.
	CK4E4011.S.020	Dis. / Des.	Appr. / Appr.
	CK4E4010.prig	Dis. / Des.	Appr. / Appr.
	1	Dis. / Des.	Appr. / Appr.
	1	Dis. / Des.	Appr. / Appr.

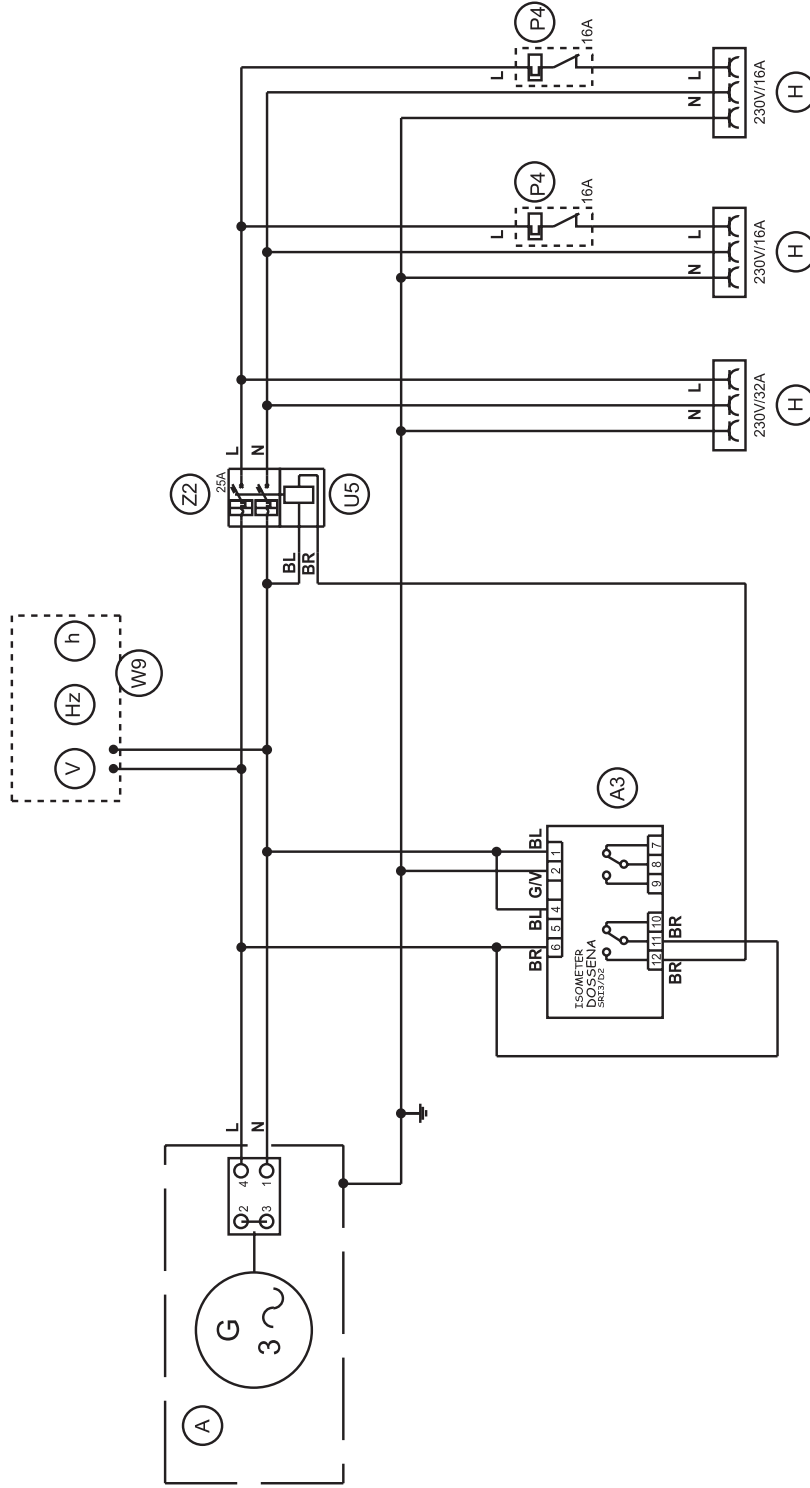

LEGENDA COLORI KEY COLOR	
GV	GIALLO/VERDE YELLOW/GREEN
BL	BLU/BLUE
BR	MARRONE/BROWN

ESP. EXP.	Modifica Modification	Data Date	Dis. Desi.	Appr. Appr.
	Denominazione: Project:	CK4E4010.prg	1	1
	Da Pag. From Page			
	Alla Pag. To Page			
	Disegnatore: Designer:	Balducci F.	Dis. n.° Dwg. n.°	Approvato: Approved:
		23.12.2016	CK4M3010.S.020	

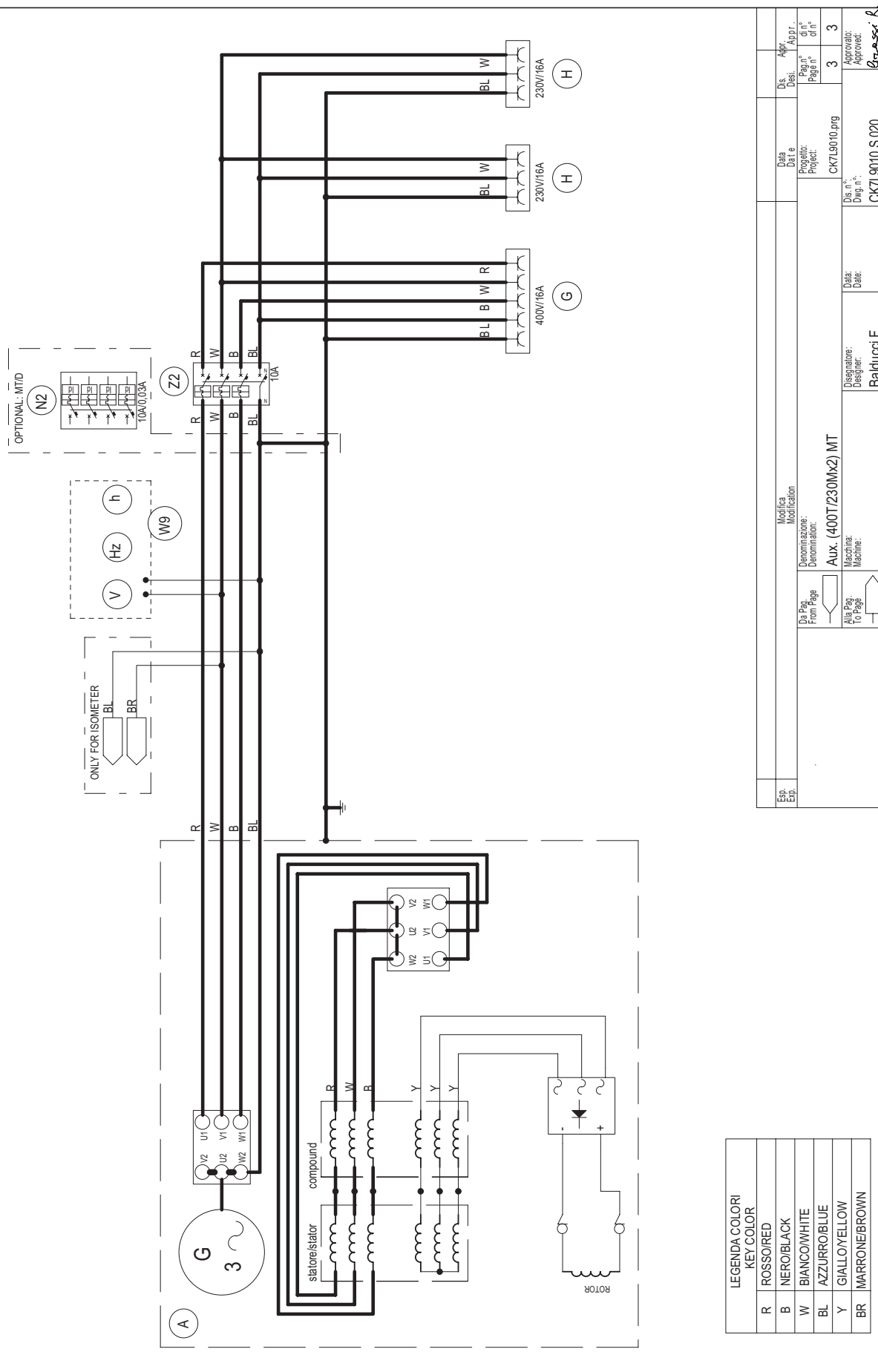

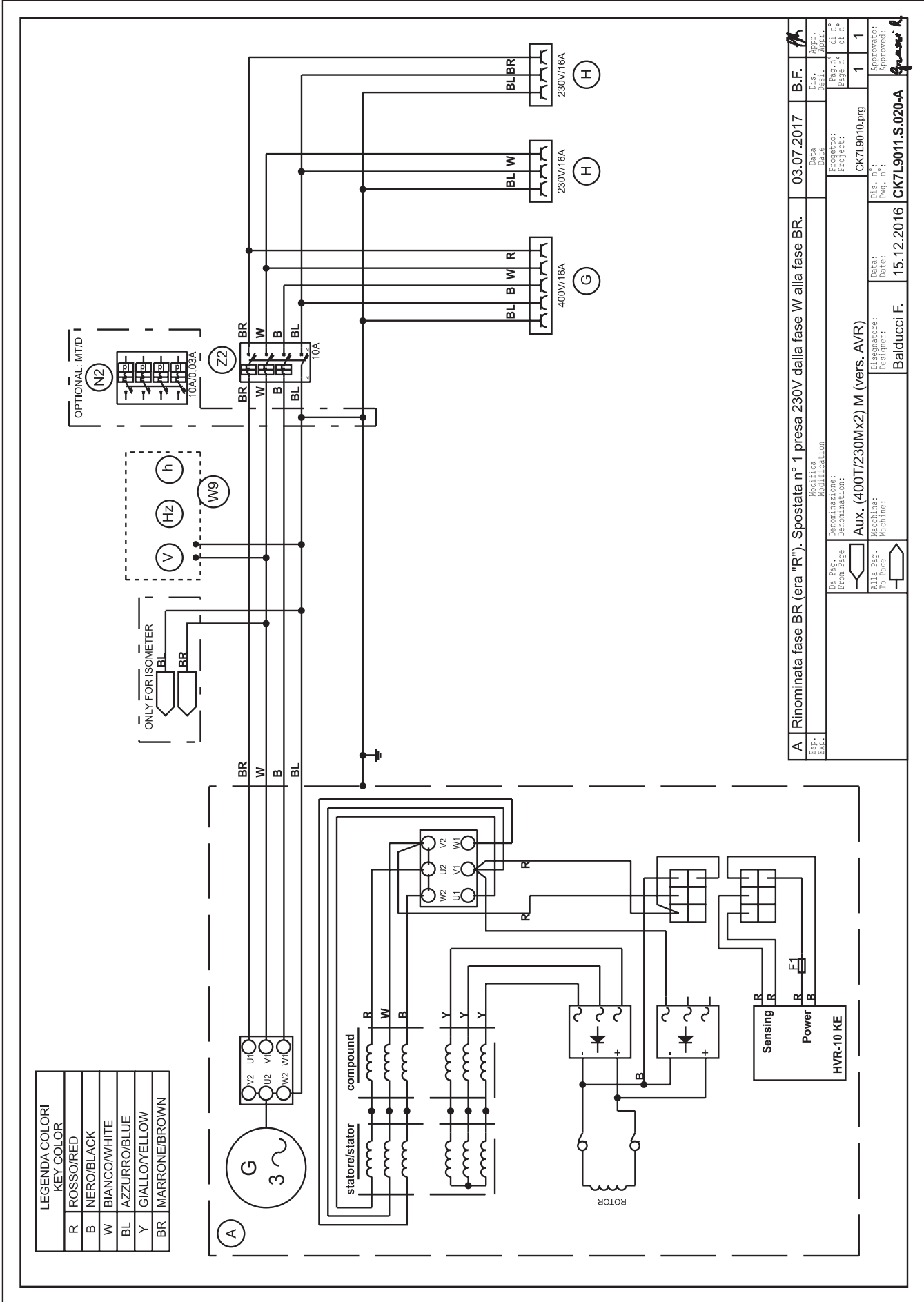

LEGENDA COLORI KEY COLOR	
R	ROSSO/RED
B	NERO/BLACK
W	BIANCO/WHITE
BL	AZZURRO/BLUE
Y	GIALLO/YELLOW
BR	MARRONE/BROWN

A		Rinominata fase BR (era "R"). Spostata n° 1 presa 230V dalla fase W alla fase BR.		03.07.2017		B.F.	
Esp.:	Modifica	Data	Progetto:	Dis. n°	Appr.	Page n°	of n°
Exc.:	Modification	Date	Project:	Page n°	Approved:	Page n°	of n°
			Aux. (400T/230Mx2) M (vers. AVR)	1		1	1
Da Pag. / From Page		Denominazione: / Denomination:		Data: / Date:		Disegnato: / Designer:	
-		Aux. (400T/230Mx2) M (vers. AVR)		15.12.2016		Balducci F.	
Alla Pag. / To Page		Macchina: / Machine:		Disegnato: / Designer:		Approvato: / Approved:	
-						Balducci F.	

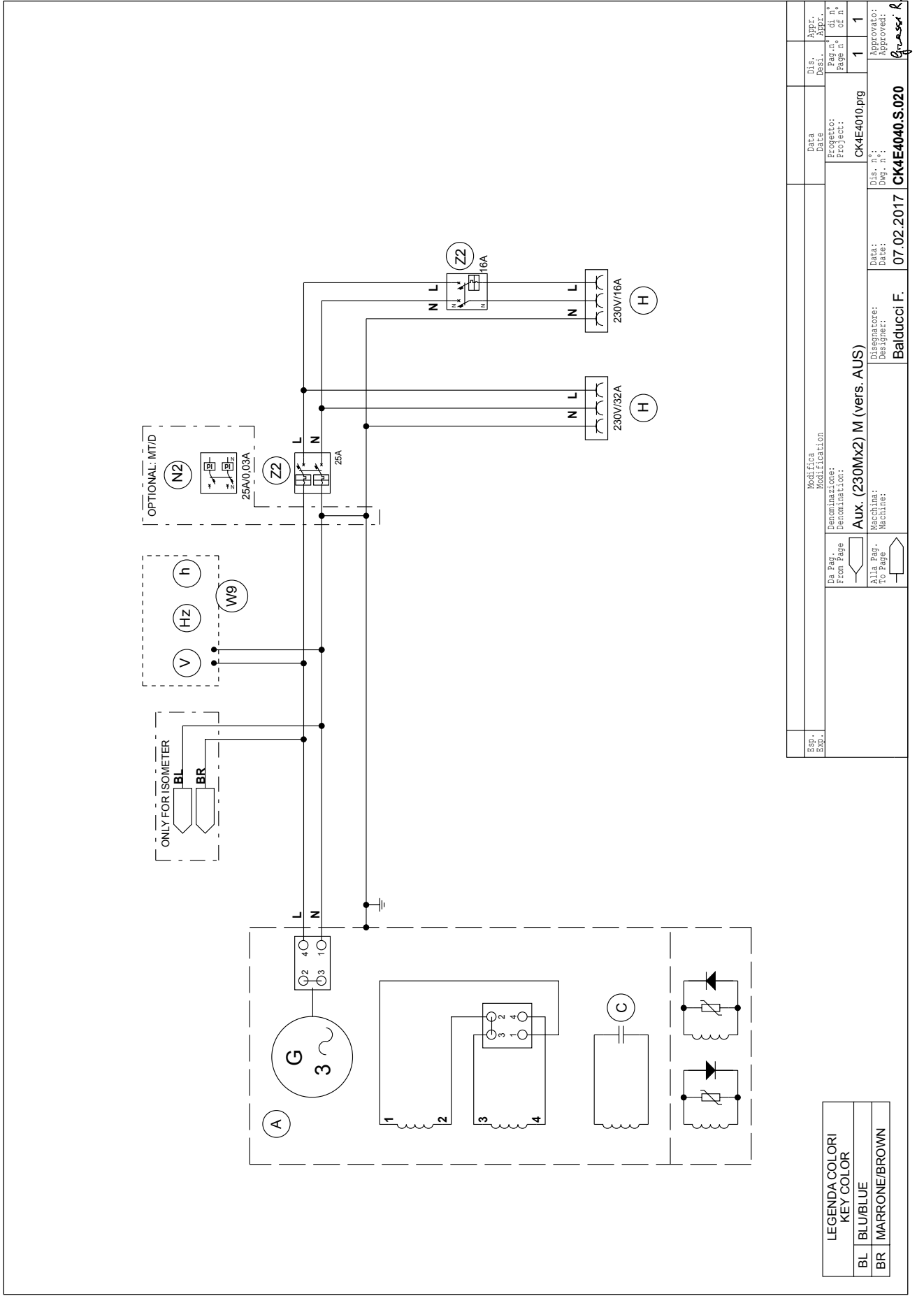

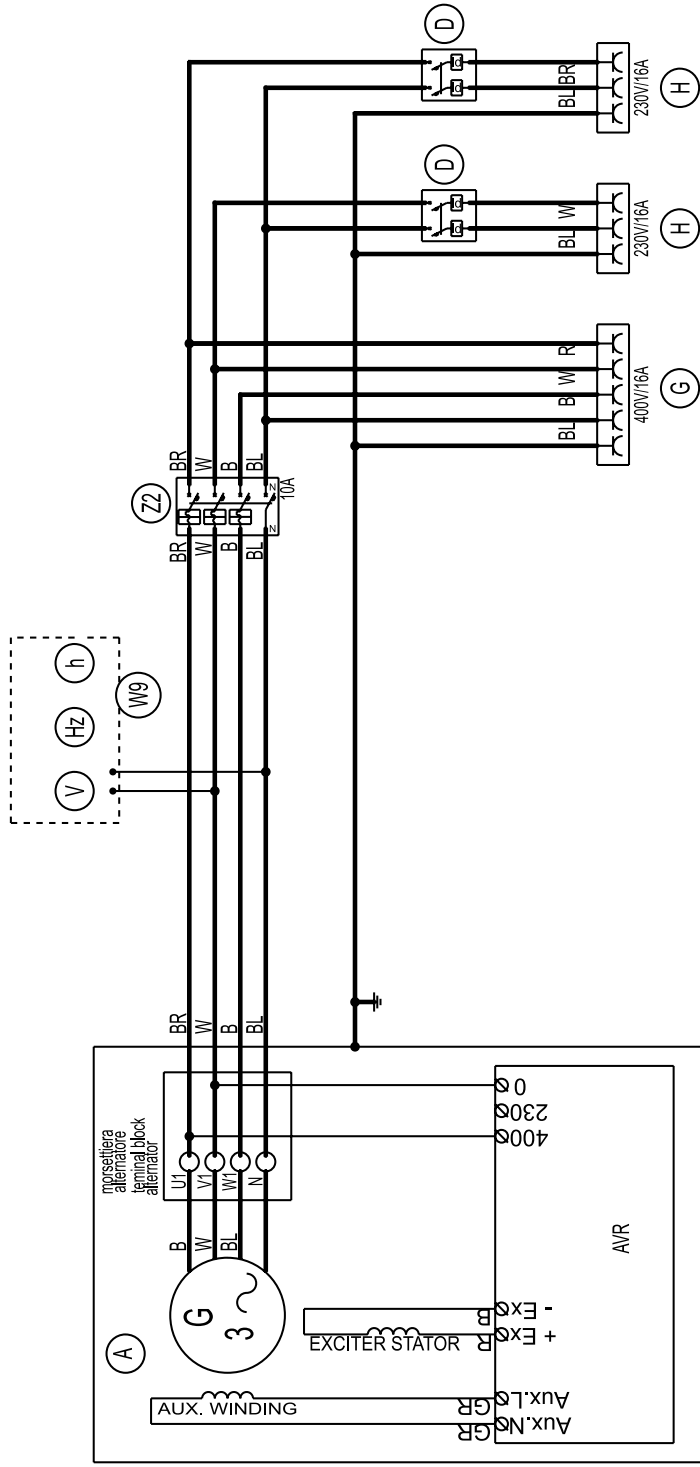

LEGENDA COLORI KEY COLOR
BL BLUE/BLU
W WHITE/BIANCO
GR GREY/GRIGIO
B BLACK/NERO
R RED/ROSSO
BR BROWN/MARRONE

ESD Exc.	Modifica Modification	Data Date	Dis. Dess.	Appr. Aubr.
Paq. n° From Page	Denominazione: Nomination:	Progetto: Project:	Paq. n° of n°	1
Paq. n° To Page	Aux. (400T/230Mx2) DM (vers. IP54)	CK7L9010.png	1	1
Dis. n° Machine:	Disegnatore: Designer:	Data: Date:	Dis. n° Dwg. n°:	Approvato: Approved:
	Balducci F.	16.02.2018	CK5E40U2.S.020	g.assi R

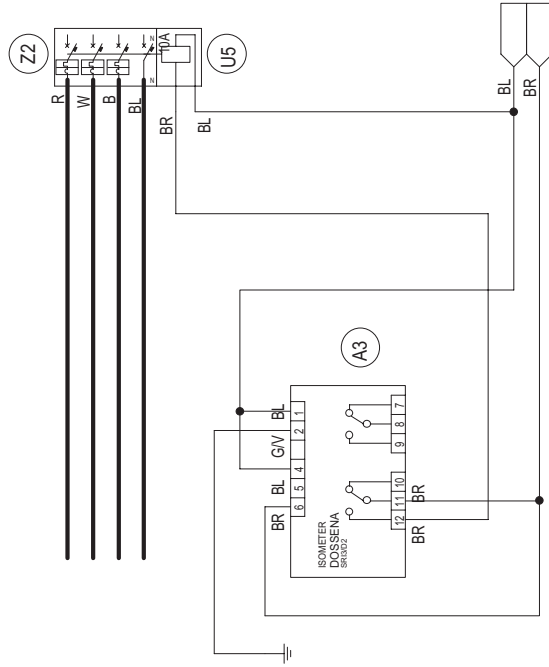

LEGENDA COLORI KEY COLOR	
G/V	GIALLO/VERDE YELLOW/GREEN
BL	BLU/BLUE
BR	MARRONE/BROWN

Esp. Exp.		Modifica Modification		Data Date		Dis. Desi. Appr. Appr.	
		Denominazione: Denomination:		Projecto: Project:		Pag. n° Page n°	
		Da Pag. From Page		CK7L9010.prg		1 1	
		Alia Pag. To Page		Dis. n° Dwg. n°:		Approvato: Approved:	
				CK7L9010.S.025		Grassl R	
		Designatore: Designer:		Date: Date:			
		Balducci F.					











**MOSA**

**MOSA div. della BCS S.p.A.**

Viale Europa, 59 20090 Cusago (Milano) Italy

Tel. +39 - 0290352.1 Fax +39 - 0290390466 [www.mosa.it](http://www.mosa.it)

