



## USE AND MAINTENANCE MANUAL

TRANSLATION OF THE ORIGINAL INSTRUCTIONS — ENGLISH

# POWER WELDERS

TS 400 YS (STAGE V)

- Motosaldatrice
- Engine Driven Welder
- Motosoudeuse
- Motosoldadoras
- Schweißaggregat
- Motosoldadora
- По Вышкам

Codice  
Code  
Code  
Codigo  
Kodezahl  
Código  
Код

C1BQ30699003

Edizione  
Edition  
Édition  
Edición  
Ausgabe  
Edição  
Издание

10.2019



MADE IN ITALY



**MOSA Weld**



**0. GENERAL INFORMATION**

M1.1	INTRODUCTION .....	PAG. 4
M1.4.2	CE MARK.....	PAG. 5
M2	SYMBOLS AND SAFETY PRECAUTIONS .....	PAG. 6
M2.1	WARNINGS.....	PAG. 7
M2.5.1...	SAFETY RULES.....	PAG. 8

**1. GENERAL INFORMATION OF THE MACHINE**

M0	DESCRIPTION OF THE MACHINE .....	PAG. 12
	RECORDING DATA.....	PAG. 13

**2. TRANSPORT AND HANDLING**

M3	MACHINE UNPACKING .....	PAG. 14
M4.2...	TRANSPORT AND HANDLING.....	PAG. 15

**3. INSTALLATION AND USE**

M2.7	INSTALLATION.....	PAG. 17
M2.6	INSTALLATION ADVICES.....	PAG. 18
	ELECTROMAGNETIC COMPATIBILITY.....	PAG. 19
M20	SET-UP FOR OPERATION DIESEL ENGINE.....	PAG. 20
	EARTHING.....	PAG. 21
	STARTING AND STOPPING.....	PAG. 22
M31	CONTROLS.....	PAG. 23
M32	CONTROLS DESCRIPTION.....	PAG. 24
M34...	USE AS WELDER.....	PAG. 25
M37...	USE AS GENERATOR.....	PAG. 27

**4. INSTRUMENTS USE**

	RECOMMENDED WELDING PARAMETERS .....	PAG. 29
M55	RECOMMENDED ELECTRODES.....	PAG. 30

**5. MAINTENANCE**

M40.1...	TROUBLE SHOOTING.....	PAG. 31
M43	MAINTENANCE.....	PAG. 34
	MAINTENANCE SCHEDULED (YANMAR TNV).....	PAG. 35
M45	STORAGE AND DISASSEMBLE .....	PAG. 36

**6. TECHNICAL INFORMATIONS**

M1.5	TECHNICAL DATA .....	PAG. 37
M1.6...	TECHNICAL DATA .....	PAG. 38
M2.7.1	DIMENSIONS.....	PAG. 39

Dear Customer,

We wish to thank you for having bought a high quality set. Our sections for Technical Service and Spare Parts will work at best to help you if it were necessary.

To this purpose we advise you, for all control and overhaul operations, to turn to the nearest authorized Service Centre, where you will obtain a prompt and specialized intervention.

☞ In case you do not profit on these Services and some arts are replaced, please ask and be sure that are used exclusively original parts; this to guarantee that the performances and the initial safety prescribed by the norms in force are re-established.

☞ *The use of **non original spare parts will cancel immediately any guarantee and Technical Service obligation.***

### NOTES ABOUT THE MANUAL

Before actioning the machine please read this manual attentively. Follow the instructions contained in it, in this way you will avoid inconveniences due to negligence, mistakes or incorrect maintenance. The manual is for qualified personnel, who knows the rules: about safety and health, installation and use of sets movable as well as fixed.

You must remember that, in case you have difficulties for use or installation or others, our Technical Service is always at your disposal for explanations or interventions.

The manual for Use Maintenance and Spare Parts is an integral part of the product. It must be kept with care during all the life of the product.

In case the machine and/or the set should be yielded to another user, this manual must also given to him.

Do not damage it, do not take parts away, do not tear pages and keep it in places protected from dampness and heat.

You must take into account that some figures contained in it want only to identify the described parts and therefore might not correspond to the machine in your possession.

### INFORMATION OF GENERAL TYPE

In the envelope given together with the machine and/or set you will find: the manual for Use Maintenance and Spare Parts, the manual for use of the engine and the tools (if included in the equipment), the guarantee (in the countries where it is prescribed by law).

The Manufacturer shall not be liable for ANY USE OF THE PRODUCT OTHER THAN THAT PRECISELY SPECIFIED IN THIS MANUAL and is thus not liable for any risks which may occur as a result of IMPROPER USE. The Company does not assume any liability for any damage to persons, animals or property.

Our products are made in conformity with the safety norms in force, for which it is advisable to use all these devices or information so that the use does not bring damage to persons or things.

While working it is advisable to keep to the personal safety norms in force in the countries to which the product is destined (clothing, work tools, etc.).

Do not modify for any motive parts of the machine (fastenings, holes, electric or mechanical devices, others..) if not duly authorized in writing: the responsibility coming from any potential intervention will fall on the executioner as in fact he becomes maker of the machine.

☞ **NOTICE:** *the manufacturer, who keeps the faculty, apart the essential characteristics of the model here described and illustrated, to bring betterments and modifications to parts and accessories, without putting this manual uptodate immediately.*



Any of our product is labelled with CE marking attesting its conformity to applicable directives and also the fulfillment of safety requirements of the product itself; the list of these directives is part of the declaration of conformity included in any machine standard equipment.

Here below the adopted symbol:



CE marking is clearly readable and unerasable and it can be either part of the data-plate.

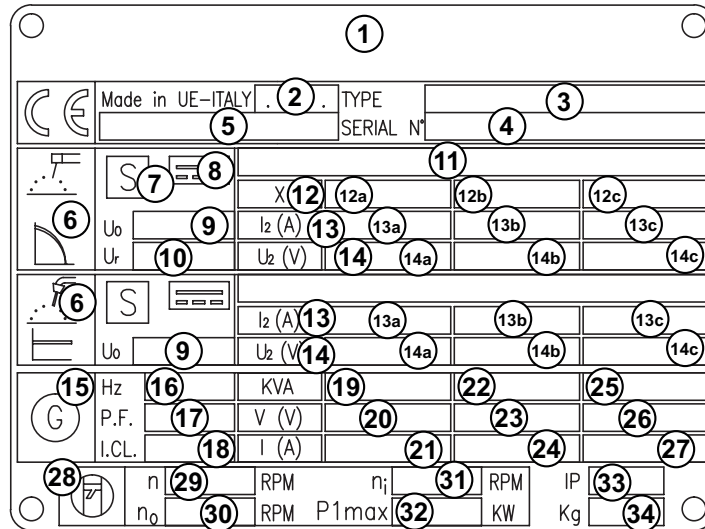

- |   |   |                          |
|---|---|--------------------------|
| 1. Manufacturer name or brand   | 11. Maximum and minimum welding current values and relative voltage value | 18. Insulation class     |
| 2. Year of production   | 12. Duty cycle symbol   | 19. Rated power (kVA/kW) |
| 3. Engine Driven Welder model   | 12a. Duty cycle values  | 20. Rated voltage (V)    |
| 4. Serial number   registration number  | 12b. Duty cycle values  | 21. Rated current (A)    |
| 5. Reference to the standard confirming that the Engine Driven Welder complies with its requirements        | 12c. Duty cycle values  | 22. Rated power (kVA/kW) |
| 6. Welding process symbol   | 13. Rated welding current symbol  | 23. Rated voltage (V)    |
| 7. Symbol for Engine Driven Welders which can be used an environment with increased risk of electric shock. | 13a. Rated welding current values   | 24. Rated current (A)    |
| 8. Welding current symbol   | 13b. Rated welding current values   | 25. Rated power (kVA/kW) |
| 9. OCV value (Rated no-load voltage) or adjustment range between minimum and maximum value                  | 13c. Rated welding current values   | 26. Rated voltage (V)    |
| 10. Reduced rated no-load voltage in case of a voltage reducing device (VRD)                                | 14. Conventional load voltage symbol                                      | 27. Rated current (A)    |
|   | 14a. Welding voltage values   | 28. Engine symbol        |
|   | 14b. Welding voltage values   | 29. Rated speed          |
|   | 14c. Welding voltage values   | 30. Rated no-load speed  |
|   | 15. Auxiliary power supply symbol   | 31. Rated idle speed     |
|   | 16. Rated frequency   | 32. Engine maximum power |
|   | 17. Power factor $\cos\phi_p$   | 33. IP degree protection |
|   |   | 34. Dry weight (kg)      |

Furthermore, on each model it is shown the noise level value; the symbol used is the following:

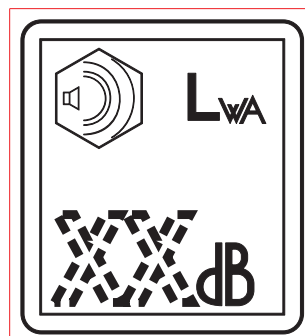







The indication is shown in a clear, readable and indeleble way on a sticker.

**SYMBOLS IN THIS MANUAL**

- The symbols used in this manual are designed to call your attention to important aspects of the operation of the machine as well as potential hazards and dangers for persons and things.  
Moreover, this symbolism intends to draw your attention with the aim to give you indications for a correct use and, as a result, to obtain a good operation of the machine or equipment used.

**SAFETY PRECAUTIONS**

	<b>DANGEROUS</b>
This heading warns of an <u>immediate</u> danger for persons as well for things. Not following the advice can result in serious injury or death.	
	<b>WARNING</b>
This heading warns of situations which could result in injury for persons or damage to things.	
	<b>CAUTION</b>
To this advice can appear a danger for persons as well as for things, for which can appear situations bringing material damage to things.	
	<b>IMPORTANT</b>
	<b>NOTE</b>
	<b>ATTENTION</b>
These headings refer to information which will assist you in the correct use of the machine and/or accessories.	

**SIMBOLS**



**STOP** - Read absolutely and be duly attentive



Read and pay due attention



**DANGER**



**GENERAL ADVICE** - If the advice is not respected damage can happen to persons or things.



**HIGH VOLTAGE** - Attention High Voltage. There can be parts in voltage, dangerous to touch. The non observance of the advice implies life danger.



**FIRE** - Danger of flame or fire. If the advice is not respected fires can happen.



**HEAT** - Hot surfaces. If the advice is not respected burns or damage to things can be caused.



**EXPLOSION** - Explosive material or danger of explosion. In general. If the advice is not respected there can be explosions.



**ACIDS** - Danger of corrosion. If the advice is not respected the acids can cause corrosions with damage to persons or things.



**PRESSION** - Danger of burns caused by the expulsion of hot liquids under pressure.

**PROHIBITIONS**

It is prohibited to smoke while filling the tank with fuel.



The cigarette can cause fire or explosion. If the advice is not respected fires or explosions can be caused.

It is prohibited to use water to quench fires on the electric machine



If the advice is not respected fires or damage to persons can be caused.

**Use only with non inserted voltage -**



It is prohibited to make interventions before having disinserted the voltage.



**ACCES FORBIDDEN** to non authorized people.

**ADVICE**

**Use only with safety clothing -**



It is compulsory to use the personal protection means given in equipment.



**WRENCH** - Use of the tools. If the advice is not respected damage can be caused to things and even to persons.



**FIRST AID.** In case the operator should be sprayed by accident, from corrosive liquids a/o hot toxic gas or whatever event which may cause serious injuries or death, predispose the first aid in accordance with the ruling labour accident standards or of local instructions.

Skin contact	Wash with water and soap
Eyes contact	Irrigate with plenty of water, if the irritation persists contact a specialist
Ingestion	Do not induce vomit as to avoid the intake of vomit into the lungs, send for a doctor
Suction of liquids from lungs	If you suppose that vomit has entered the lungs (as in case of spontaneous vomit) take the subject to the hospital with the utmost urgency
Inhalation	In case of exposure to high concentration of vapours take immediately to a non polluted zone the person involved



**FIRE PREVENTION.** In case the working zone, for whatsoever cause goes on fire with flames liable to cause severe wounds or death, follow the first aid as described by the ruling norms or local ones.

EXTINCTION MEANS	
Appropriated	Carbonate anhydride (or carbon dioxide) powder, foam, nebulized water
Not to be used	Avoid the use of water jets
Other indications	Cover eventual shedding not on fire with foam or sand, use water jets to cool off the surfaces close to the fire
Particular protection	Wear an autorespiratory mask when heavy smoke is present
Useful warnings	Avoid, by appropriate means to have oil sprays over metallic hot surfaces or over electric contacts (switches, plugs, etc.). In case of oil sprinkling from pressure circuits, keep in mind that the inflamability point is very low.

## GENERAL SAFETY INSTRUCTIONS

**NOTE:** the information contained in this manual are subject to change without notice.

The instructions in this manual are intended as indicative only. It is the responsibility of the owner/operator to evaluate risks and potential damages in relation to the use of the product in the specific conditions of application. Remember that the non observance of the indications of this manual may result in damage to people or things.

In all cases, however, it is understood that the use shall be in compliance with the applicable laws/regulations.

- Before operating the machine, read carefully the safety instructions contained in this manual and other manuals supplied (engine, alternator, etc.).
- All operations, handling, installation, use, maintenance, repair should be carried out by authorized and qualified personnel.
- When operating, wear personal protective equipment (PPE): footwear, gloves, helmet, etc..
- The owner is responsible for maintaining the equipment in safe conditions.

### Use only in perfect technical conditions

The machinery or equipment must be used in perfect technical condition. Remove immediately any defects that may affect the safe conditions of use.

- Before starting to use this equipment it is important to take knowledge of all the controls of the machine, all its functions and its correct installation in order to avoid accidents to people and damage to the machine itself. In particular, it is important to know how to stop the equipment quickly in case of emergency.
- Do not allow the use of the machine to people unless previously instructed with all the information for a proper, safe use.
- Forbid the access in the operational area to non authorized personnel, children and pets so as to protect them from possible injury caused by any part of the machine.

## SAFETY PRECAUTIONS DURING HANDLING AND TRANSPORTATION





- Lift the machine using only the points allocated for this function.  
The lifting eye (or eyes) and the correct positioning of the forks of the forklift are marked with specific adhesives.
- Clear the operational area of possible obstacles and all unnecessary personnel.
- Always use lifting equipment properly sized and controlled by enabled bodies.
- It is forbidden to set on the frame of the equipment objects or accessories that alter weight and center of gravity and cause stresses not foreseen to the lifting points.
- Do not submit the machine and the lifting equipment to swinging or shock which may transmit dynamic stress to the structure.





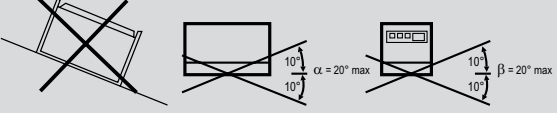
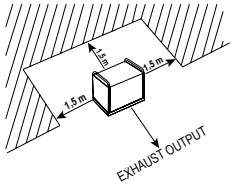

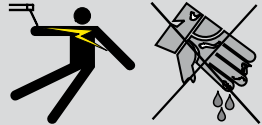
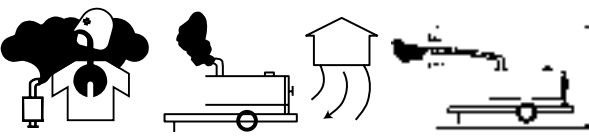
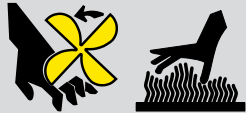



### Equipments with trailers or site tows

- Never drag the machine without trailer (or site tow)
- Check for a correct assembly of the machine to the towing device.
- Always make sure that the hook of the vehicle is suitable for towing of the total mass of the trailer.
- Do not tow the trailer if the coupling devices are worn or damaged.
- Check for proper tire pressure.











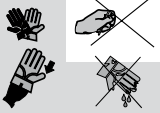

- Do not replace the tires with types different from the original ones.
- Check that the brakes and the optical signaling of the trailer are working properly.
- Verify that the bolts of the wheels are in place and well tightened.
- Do not park the machine (on trailer or site tow) on a steep slope.  
For the stops, not followed by a work session, always engage the parking brake and / or block the wheels by means of wheel chocks.
- Do not tow the trailer on bumpy roads.
- Do not exceed the maximum permissible speed on public roads of 80 km/h with the trailer, in any case comply with the legislation applicable in the country of use.
- Do not use the site tow on public roads, this is intended for use only in private and delimited areas. The maximum permitted speed is 40 km/h on smooth surfaces (asphalt or concrete), adapt in each case the speed to the type of ground.



SAFETY PRECAUTIONS DURING INSTALLATION AND USE	
	Do not instal equipments closed to heat source, to explosion or fire risk area.
	Always locate the machine on a flat and solid ground, so as to avoid tipping, slipping or falling during operation. Avoid using the machine on slopes greater than 10 degrees.
	Make sure the area immediately surrounding the machine is clean and free from debris
	Do not place objects or obstructions in the vicinity of the air intakes and air outlets, a possible overheating of the generator could cause a fire.
	Connect the machine to an earthing system according to the regulations in force at the place of installation. Use the ground terminal on the front of the machine.
	Do not use the machine with wet or damp hands and / or clothing. Use plugs suitable for the output sockets of the machine and make sure that electrical cords are in good condition.
	The machine must always be positioned so that the exhaust gases are dispersed in the air without being inhaled by people or living beings. If you use the machine indoors is necessary that the installation is designed and built by skilled technicians in a workmanlike manner.
	During normal operation, keep doors closed. The access to the internal parts should be allowed only for maintenance reasons.
	Keep area near to the muffler free from objects such as rags, paper, cardboard. The high temperature of the muffler could cause the burning of objects and cause fire
	Immediately stop the machine in case of malfunction. Do not restart the machine without first having found and fixed the problem.

<b>SAFETY PRECAUTIONS DURING MAINTENANCE</b>	
Make use of qualified personnel to carry out maintenance and troubleshooting	
	It is mandatory to stop the engine before performing any maintenance on the machine.
	Always use protective devices and suitable equipment.
	Do not touch the engine, the exhaust pipes and the muffler during operation or immediately after. Allow the engine to cool before performing any operation
	With the machine running pay attention to moving parts such as fans, belts, pulleys. Do not remove the protections and the safety devices unless absolutely necessary, restore them after completion of the maintenance or repair.
	Do not refuel while the engine is running or hot. Do not smoke or use naked flames when refueling.
	Refuel only outdoors or in well ventilated areas. Avoid spilling fuel, especially on the engine. Clean and dry any leaks before restarting the machine
	Slowly unscrew the cap of the fuel tank and put it back always after refueling. Do not fill the tank completely to allow for expansion of the fuel inside
	Do not remove the radiator cap when the engine is running or still hot, the coolant may spurt out and cause serious burns
	Do not handle the battery without the use of protective gloves, the battery fluid contains sulfuric acid, which is very corrosive and dangerous
	Do not smoke, avoid any naked flames or sparks near the battery, the vapors exhaled could cause the battery to explode

ADDITIONAL REQUIREMENTS FOR ENGINE DRIVEN WELDERS

	<p>Do not touch parts with OCV, it can cause mortal shock or heavy born. OCV is active at welding stick and auxiliary side when welding generating set is working.</p>
	<p>Do not manage electric devices and welding stick whit feet, hands or wet dresses.</p>
	<p>Protect yourself from electric shock by insulating yourself from work and ground. Use non-flammable, dry insulating material if possible, or use dry rubber amts, dry wood or plywood, or other dry insulating material.</p>
	<p>Magnetic fields can affect pace-makers. Pace-maker wearers keep away from arc welding and cutting operations and equipment. Wearers should consult their doctor before going near arc welding, gouging, arc cutting, or spot welding operations.</p>
	<p>Breathing welding fumes can be hazardous to your health. Keep your out of the fumes</p>
	<p>Use enough ventilation, exhaust at the arc, or both, to keep fumes and gases from your breathing zone and the general area. If adequacy of ventilation or exhaust is uncertain, have the air quality checked.</p>
	<p>Arc rays can burn eyes and skin. Use welding helmet with correct shade of filter.</p>
	<p>While working protect your eyes using glasses with lateral screen and your head with dedicated cap; in case of restricted working area or unsafe working position also protect your ears.</p>
	<p>Wear complete body protection. Wear oil free protective clothing such as leather gloves, heavy shirt, cuffless pants, and hight boots.</p>
	<p>Welding can cause fire or explosion. Have a fire extinguisher nearby, and have a trained fire watcher ready to use it.</p>
	<p>Do not weld near flammable material. Move flammanles at least (10 m) away or protect them with flame-proof covers.</p>
	<p>Do not weld containers, structures, etc. with fammable materials inside (tank, cylinder, etc.); in case you need to weld, verify such items by qualified person in order to fully safely operate.</p>
	<p>Hot parts can cause severe burns. Don't touch the welder with bare hand. If handling is needed, use proper tools and/or wear heavy, insulated welding gloves to prevent burns. Allow cooling period before handing parts or working on gun or torch.</p>

ENGLISH

ENGLISH

The TS 400 YS is a unit which ensures the dual function as:

- a current source for are welding
- current generator for generating auxiliary

Unit meant for industrial and professional use. Powered by an endothermic engine; it is composed of various parts such as: engine, alternator, electric and electronic controls, the fairing at a protective structure. The assembling is made on a steel structure, on which are provided elastic support which must damp the vibrations and also eliminate sounds which would produce noise.

ENGLISH

ENGLISH

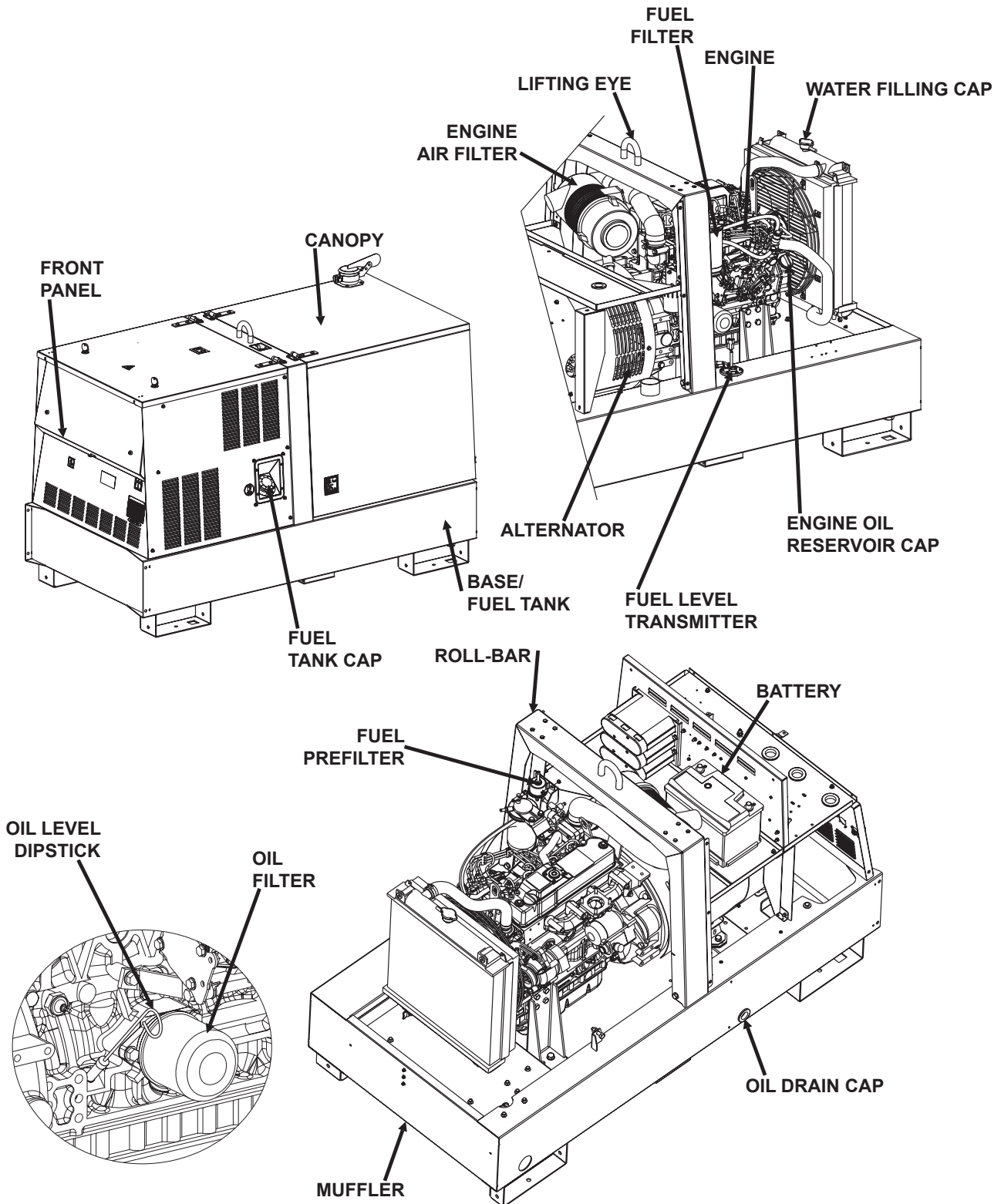

.....  
The manual is for the range of machines indicated on the front cover.

With the scope to facilitate the search of the spare parts and maintain information of the bought machine, is necessary to record some data.

**Please write the requested data inside the squares to side:**

1. Model of machine
2. Serial number of the machine
3. Serial number of the engine
4. Name of the dealer where bought the machine
5. Address of the dealer
6. Phone number of the dealer
7. Date of the bought machine
8. Notes

ENGLISH

ENGLISH

### RECORDING DATA

1. \_\_\_\_\_

2. \_\_\_\_\_

3. \_\_\_\_\_

4. \_\_\_\_\_

\_\_\_\_\_

5. \_\_\_\_\_

\_\_\_\_\_

6. \_\_\_\_\_

\_\_\_\_\_

7. \_\_\_\_\_

\_\_\_\_\_

8. \_\_\_\_\_

\_\_\_\_\_

\_\_\_\_\_

\_\_\_\_\_

\_\_\_\_\_

\_\_\_\_\_

\_\_\_\_\_

 **NOTE**

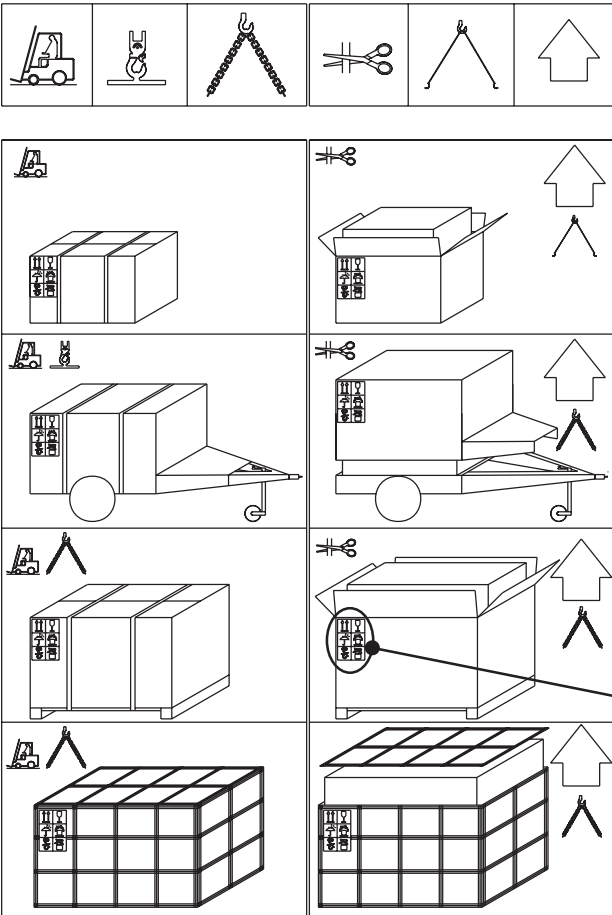

Be sure that the lifting devices are: correctly mounted, adequate for the weight of the machine with its packaging, and conforms to local rules and regulations. When receiving the goods make sure that the product has not suffered damage during the transport, that there has not been rough handling or taking away of parts contained inside the packing or in the set. In case you find damages, rough handling or absence of parts (envelopes, manuals, etc.), we advise you to inform immediately our Technical Service.



For eliminating the packing materials, the User must keep to the norms in force in his country.

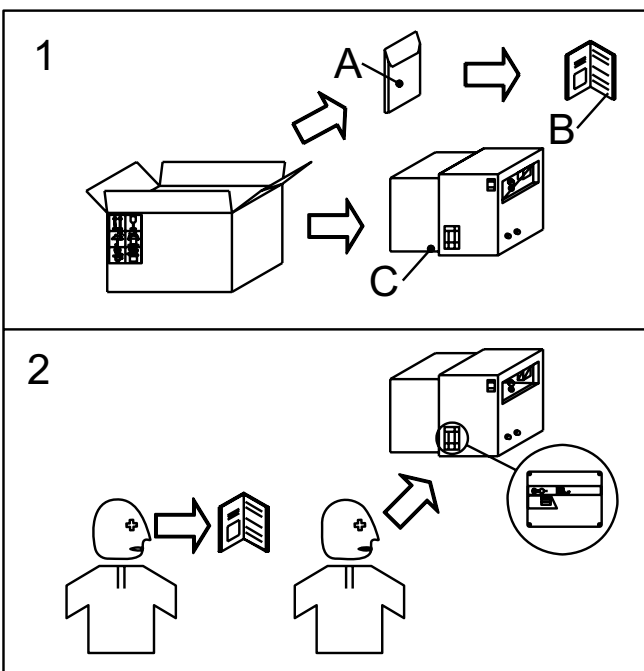
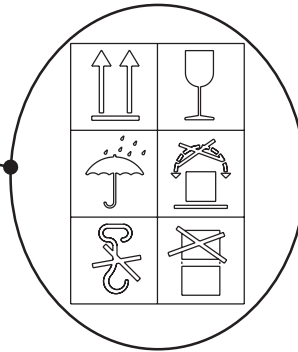

- 1) Take the machine (C) out of the shipment packing. Takeout of the envelope (A) the user's manual (B).
- 2) Read: the user's manual (B), the plates fixed on the machine, the data plate.



**GENERAL PRECAUTIONS WHEN HANDLING THE MACHINE.**



## ATTENTION



**When moving/lifting a genset it is imperative to be extremely careful. All moving operations must be carried out by qualified persons.**

**Due to the weight and encumbrance of the genset, an error while moving/lifting the unit may cause serious damage to it or surrounding persons.**

To limit the dangers involved in moving a generating set, it is important to carefully follow the guideline set out below:

- Transportation must always take place with the engine off and electrical cables and starting battery disconnected and fuel tank empty.
- Particular attention must be paid to SKID version generating sets (without canopy) that have very delicate parts unprotected from bumps (injection pump, speed regulator, radiator, electrical panel connections and instrumentation).
- Generating sets must be protected from bad weather during transport: the units must be entirely covered, especially the electrical parts (alternator and control panel).
- Some engine parts retain heat even after it has been shut off: therefore it is necessary to wait for the engine to cool before covering it to avoid the risk of fire.
- Clear the moving zone of all possible obstacles and from all unnecessary personnel.
- Use properly sized lifting equipment regularly submitted to major overhaul by an authorized organisation. It is prohibited to fasten objects or accessories on the generating set baseframe that may modify weight and center of gravity and may cause movements unforeseen by the lifting eyes.
- Do not subject the generating set and lifting equipment to abrupt or undulating movements that pass on stress dynamics to the structure.
- Do not lift the generating set higher than what is absolutely necessary.
- Transportation of separate manual or automatic control panels must be carried out very carefully in order to avoid damage to the equipment contained inside the panel and to the instruments on the front.
- To access the hook points on the top of the unit, use approved ladders only or support from another operator: climb the ladder using non-skid shoes.

**MOVING METHOD**

The generating sets are lifted with different methods according to the unit's configuration. Below are the main methods of moving/lifting the genset.

**MOVING THE GENERATING SET VIA FORKLIFT**

When lifting with a forklift it is necessary to fork the baseframe sideways so that the forks stick out from one side to the other side, widening them to distribute the weight properly, maintaining the genset level.

Stickers on the base indicate where to place the lifter forks.

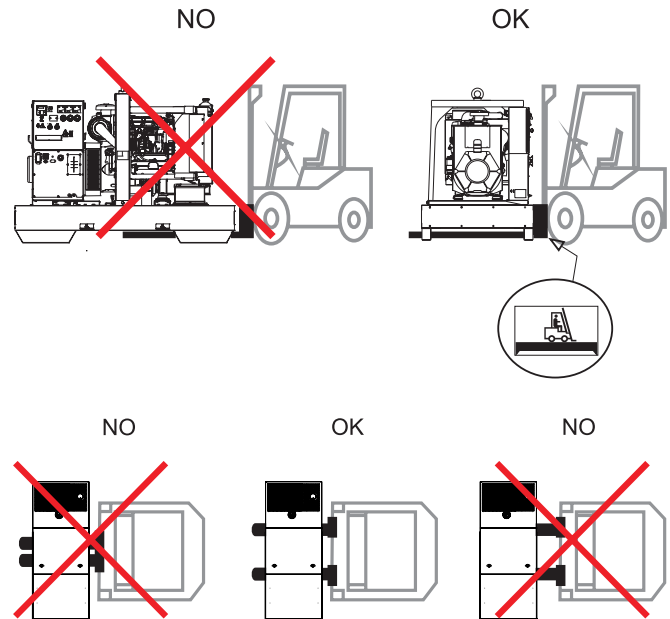
**MOVING THE GENERATING SET VIA CABLES OR CHAINS**

When lifting the genset with the aid of cables or chains it is necessary to use equipment periodically checked by a licensed organisation. Hook the cables only on to the points provided for this use and shown via the appropriate stickers.

For correctly moving the generating set:

- DO NOT lift the genset by fastening cables to the lifting eyes on the engine or alternator (these are only used for lifting the single components).
- DO NOT make abrupt or undulating movements that pass on stress dynamics to the structure.
- DO NOT leave the generating set suspended for longer than absolutely necessary to move the unit.
- Use all the lifting eyes provided.
- Use cables and/or chains of equal length so that the weight is distributed evenly.

MOVING THE GENERATING SET VIA CABLES OR CHAINS

ENGLISH

ENGLISH

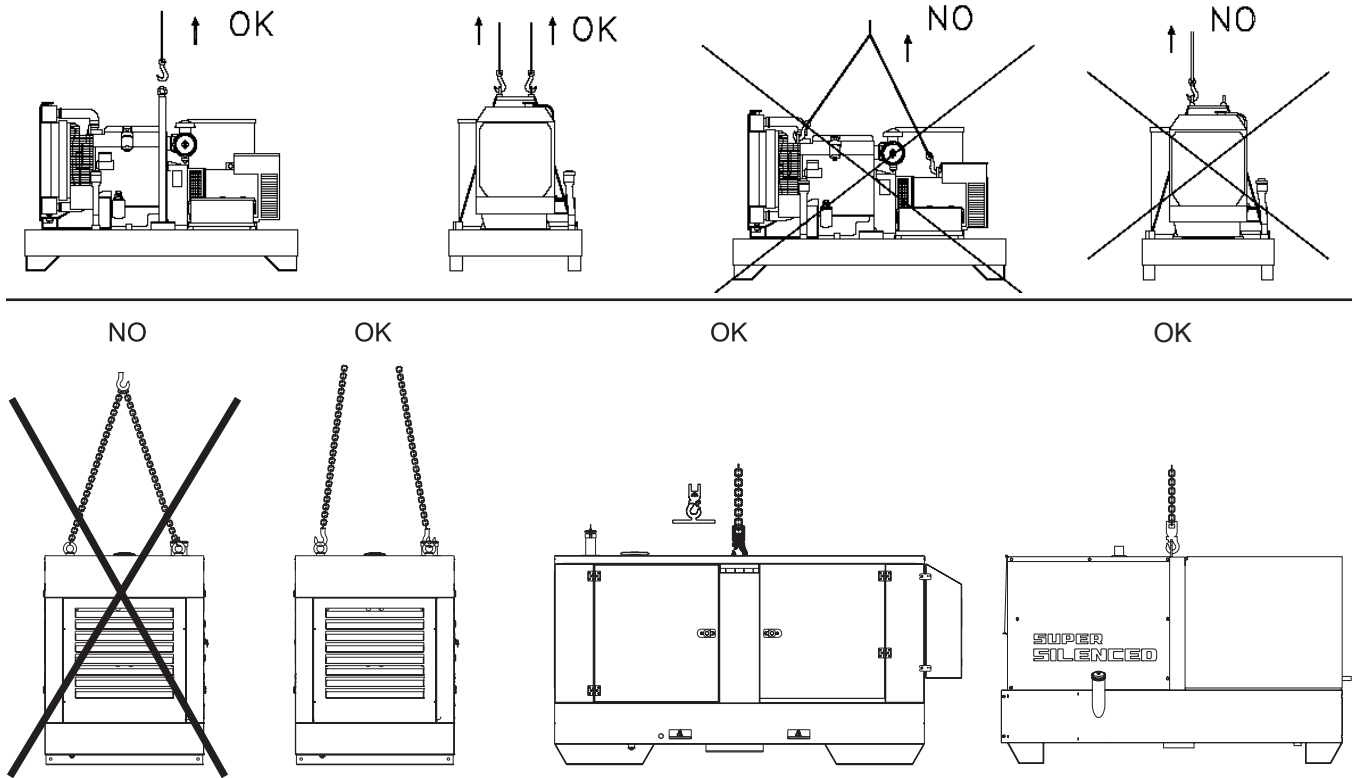

MOVING BY SITE TROLLEY / TRAILER

**BEWARE**

**DO NOT TOW** the generating set without trailer, be it manually or using a vehicle.

Trolleys/trailers should only be used to move the generating set for which they were designed.

ROAD TROLLEY CTV:

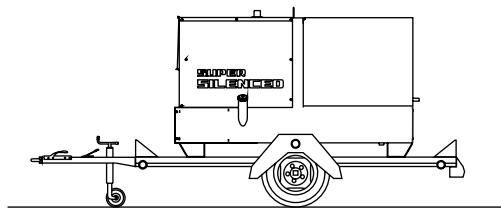

made by using a general use standard trailer on which the genset is fixed: it is type approved for transport on public roads by licensed organisations. The maximum speed allowed is 80 km/h however, the transportation laws in force in the place of

use should be respected.

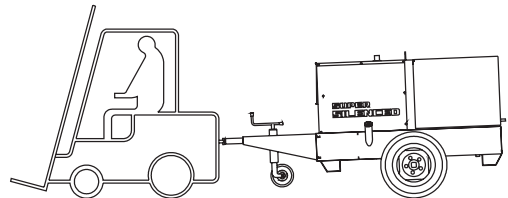

**SITE TOW CTL:**

this trailer is made by the manufacturer and connected to the generating set baseframe, it can not be towed on public roads. Therefore it can only be used on private roads and no through traffic zones.

The maximum speed allowed is 40 km/h on smooth surfaces (asphalt, cement) and, in any case, the laws in force in the place of use should be respected.

Always follow the directions below for any type of tow:

- DO NOT park the generating set/trolley assy, on slant ground
- When parking always use the emergency/hand brake and/ or safety clamps.
- DO NOT tow the trailer on bumpy roads.

**MOVING THE UNIT VIA MOTOR VEHICLE**

During transportation with a motor vehicle, it is important to use appropriate belts/straps to stabilise the unit, therefore avoiding that unexpected bumps or jolts can cause damage to the baseframe, engine, or worse, overturn the load. It is the carrier's responsibility to always respect the highway code in force.





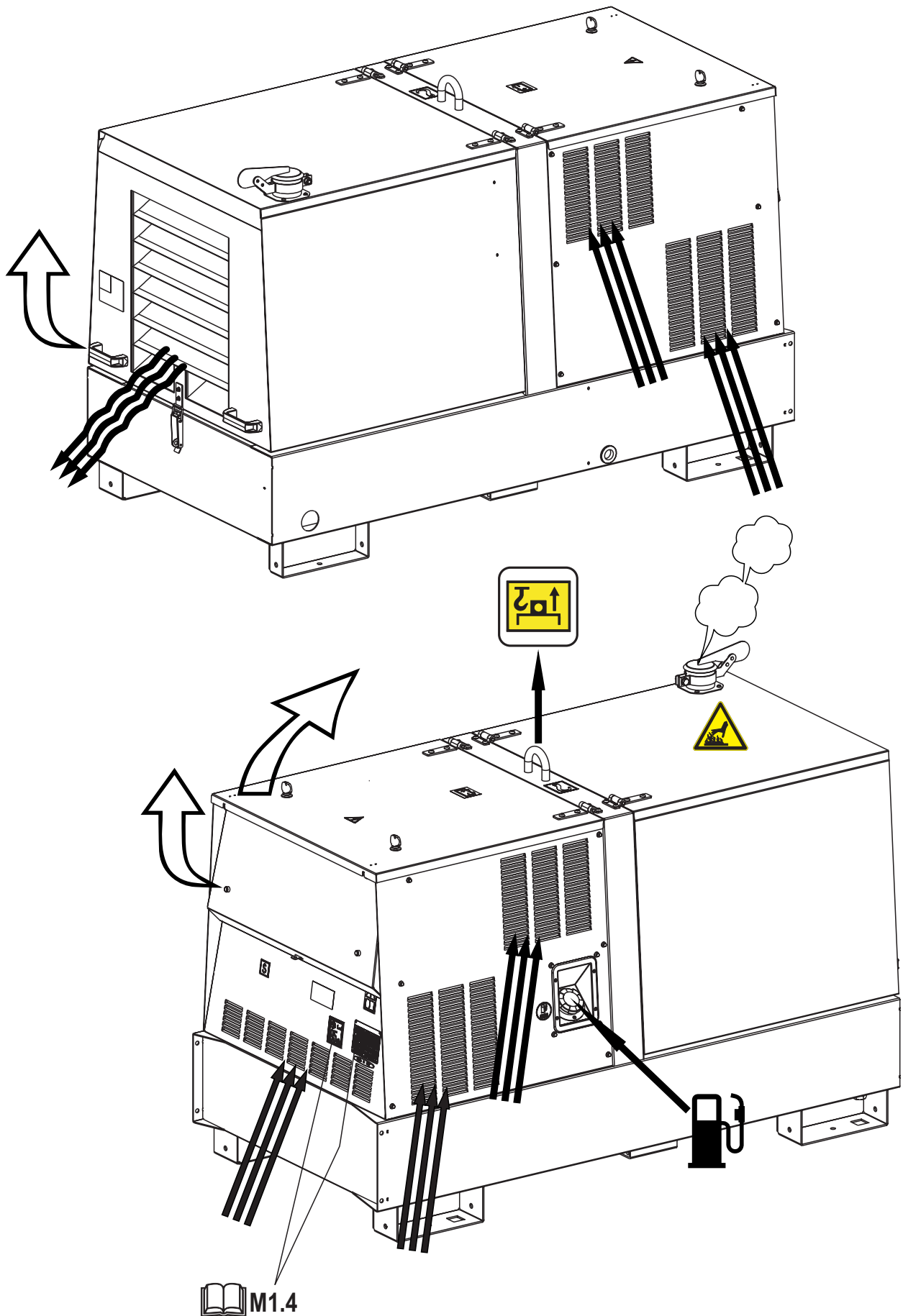

## INSTALLATION AND ADVICE BEFORE USE

The operator of the welder is responsible for the security of the people who work with the welder and for those in the vicinity.

Before installing the welder machine, read the safety instruction of this manual at the chapter 2.5.

Particularly remember:

- installing operation must be made by authorized and qualified person.
- while installing operation use individual safety devices (shoes, gloves, cap, etc.)

### DANGER

The machine must be positioned so that exhaust gas is diffused without being inhaled by any living being. Engine exhaust gas contains carbon monoxide, which is harmful to one's health, and in big quantities can cause intoxication and death. Local norms in force have to be respected.

### ATTENTION

A safe distance has to be kept between the machine and fuel deposits, inflammable goods (cloths, paper, etc.), chemicals, according to indications provided by the authority in charge. In order to avoid potentially dangerous situations, area surrounding genset should be isolated so that unauthorized people will not be able to get close to the unit. Even if The machines are manufactured according to electromagnetic compatibility norms, we suggest NOT to install the genset near machinery that can be influenced by magnetic fields.

### ATTENTION

This equipment is designed for outdoor use. It may be stored, but is not intended to be used when welding outside during precipitation unless sheltered

## INSTALLATION

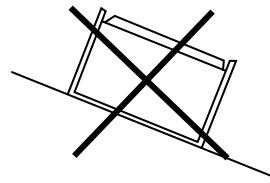

Always instal the welder machine on a hard and plan surface in order to avoid rollovers, slips or falls while working;  
avoid to use the welder machine with slope more than 10°.

## FIXING

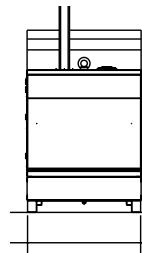

In order to absorb vibrations produced by genset, it should be fixed to a surface with sufficient rigidity, isolated against vibrations towards other structures and with a mass equal to at least three times the genset mass. If such above could not be possible, be sure that the welding machine do not move or slip while working due to vibrations; be care to fix the welder machine with dedicated tools.

## MOVING THE WELDER MACHINE

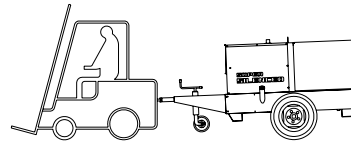

If is needed to move the welder machine be sure that the engine is off, that no electric connection is on and that noone cable will avoid to move the welder machine.

## INSTALLATION ON VEHICLE

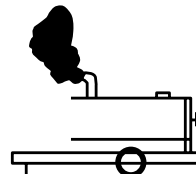

The wrong loads distribution can cause the instability of the vehicle and abnormalities to wheel and components. In case of transport need, use dedicated vehicle for this purpose. The loads must be balanced, fixed in order to guaranty the stability of the vehicle. Do not exceed the max load suitable of the vehicle with reference to axle, wheels, etc. Fix the base of welder machine at the frame or platform observing the instruction of the vehicle producer



This equipment is built in compliance with standard IEC-EN60974-10.

The equipment should be installed and used in accordance with the information below to achieve electromagnetic compatibility. The limits required by IEC-EN60974-10 may not be adequate to completely eliminate interference when the affected equipment is in close proximity or has a high degree of sensitivity. In such cases it may be necessary to use other measures to further reduce interference



## WARNING

this Class A equipment is not intended for use in residential locations where the electrical power is provided by the public low-voltage supply system. There may be potential difficulties in ensuring electromagnetic compatibility in those locations, due to conducted as well as radiated disturbances.

### INSTALLATION AND USE

The user is responsible for installing and using the arc welding equipment according to the manufacturer's instructions.

If electromagnetic disturbances are detected, then it shall be the responsibility of the user resolve the situation with the technical assistance of the manufacturer.

In some cases this remedial action may be as simple as earthing the welding circuit (see note). In other cases, it could involve constructing an electromagnetic screen enclosing the welding power source and the work complete with associated filters

In all cases electromagnetic disturbances shall be reduced to the point where they are no longer troublesome.

**NOTE** : The welding circuit may or may not be earthed for safety reasons. Changing the earthing arrangements should only be authorized by a person who is competent to assess whether the changes will increase the risk of injury, for example, by allowing parallel welding current return paths, which may damage the earth circuits of other equipment. Further guidance is given in IEC/TS 620812.

### ASSESSMENT OF AREA

Before installing arc welding equipment the user shall make an assessment of potential electromagnetic problems in the surrounding area. The following shall be taken into account:

- A) other supply cables, control cables, signalling and telephone cables, above, below and adjacent to the arc welding equipment;
- B) radio and television transmitters and receivers;
- C) computer and other control equipment;
- D) safety critical equipment, for example guarding of industrial equipment;
- E) the health of the people around, for example the use of pacemakers and hearing aids;
- F) equipment used for calibration or measurement;
- G) the immunity of other equipment in the environment. The user shall ensure that other equipment being used in the environment is compatible. This may require additional protection measures;
- H) the time of day that welding or other activities are to be carried out.

The size of the surrounding area to be considered will depend on the structure of the building and other activities that are taking place. The surrounding area may extend beyond the boundaries of the premises.

### METHODS OF REDUCING EMISSIONS

#### MAINTENANCE OF THE ARC WELDING EQUIPMENT

The arc welding equipment should be routinely maintained according to the manufacturer's recommendations. All access and service doors and covers should be closed and properly fastened when the arc welding equipment is in operation. The arc welding equipment should not be modified in any way, except for those changes and adjustments covered in the manufacturer's instructions.

#### WELDING CABLES

The welding cables should be kept as short as possible and should be positioned close together, running at or close to the floor level.

#### EQUIPOTENTIAL BONDING

Bonding of all metallic objects in the surrounding area should be considered. However, metallic objects bonded to the work piece will increase the risk that the operator could receive an electric shock by touching these metallic objects and the electrode at the same time. The operator should be insulated from all such bonded metallic objects.

#### EARTHING OF THE WORKPIECE

Where the workpiece is not bonded to earth for electrical safety, nor connected to earth because of its size and position, for example, ship's hull or building steelwork, a connection bonding the workpiece to earth may reduce emissions in some, but not all instances. Care should be taken to prevent the earthing of the workpiece increasing the risk of injury to users or damage to other electrical equipment.

Where necessary, the connection of the workpiece to earth should be made by a direct connection to the workpiece, but in some countries where direct connection is not permitted, the bonding should be achieved by suitable capacitance, selected according to national regulations.

#### SCREENING AND SHIELDING

Selective screening and shielding of other cables and equipment in the surrounding area may alleviate problems of interference. Screening of the entire welding area may be considered for special applications.





### BATTERY WITHOUT MAINTENANCE



The starter battery is supplied already charged and ready for use. Before starting the gen-set connect the cable + (positive) to the pole + of the battery, by properly tightening the clamp. In case of models with warning light: check the state of the battery by means of the indicator placed in the upper part.

- Green colour: battery OK
  - Black colour: battery to be recharged
  - White colour: battery to be replaced
- DO NOT OPEN THE BATTERY.**



### LUBRICANT

#### RECOMMENDED OIL

The manufacturer recommends selecting **AGIP** engine oil. Refer to the label on the motor for the recommended products. Please refer to the motor operating manual for the recommended viscosity.

#### REFUELLING AND CONTROL:

Carry out refuelling and controls with motor at level position.

1. Remove the oil-fill tap (24)
2. Pour oil and replace the tap
3. Check the oil level using the dipstick (23); the oil level must be comprised between the minimum and maximum indicators.



### ATTENTION

It is dangerous to fill the motor with too much oil, as its combustion can provoke a sudden increase in rotation speed.



### AIR FILTER

Check that the dry air filter is correctly installed and that there are no leaks around the filter which could lead to infiltrations of non-filtered air to the inside of the motor.



### FUEL



### ATTENTION



Stop engine when fueling. Do not smoke or use open flames during refuelling operations, in order to avoid explosions or fire hazards.



Fuel fumes are highly toxic; carry out operations outdoors only, or in a well-ventilated environment. Avoid accidentally spilling fuel. Clean any eventual leaks before starting up motor.

Refill the tank with good quality diesel fuel, such as automobile type diesel fuel, for example.

For further details on the type of diesel fuel to use, see the motor operating manual supplied.

Do not fill the tank completely; leave a space of approx. 10 mm between the fuel level and the wall of the tank to allow for expansion.

In rigid environmental temperature conditions, use special winterized diesel fuels or specific additives in order to avoid the formation of paraffin.



### COOLING LIQUID



### ATTENTION



Do not remove the radiator tap with the motor in operation or still hot, as the liquid coolant may spurt out and cause serious burns. Remove the tap very carefully.

Remove the tap and pour the liquid coolant into the radiator; the quantity and composition of the liquid coolant are indicated in the motor operating manual. Replace the tap, ensuring it is perfectly closed.

After refilling operations, allow the motor to run for a brief time and check the level, as it may have diminished due to air bubbles present in the cooling circuit; restore the level with water. To replace the liquid coolant, follow the operations described in the motor operating manual.

#### ATTENTION:

The engine cooling system is originally filled with coolant type: **AGIP ANTIFREEZE EXTRA**

During the engine life it is strongly recommended to use the same coolant type. This is because a coolant change would require a careful cleaning of the cooling system, which is not an easy job. A lack in tacking these precautions would result in the mix of different additives used in different coolants which would originate gelatinous substances capable of obstructing the cooling system.

#### ELECTRICAL CONNECTIONS



### ATTENTION



A qualified electrician should carry out electrical connections according to the norms in force.

The electrical connection to the User system is a very important operation: safety and good operation of the genset and User system depend on a correct electrical connection.

Before supplying User system always check:

- that wires connecting gen-set to the user plant are suitable to the supplied voltage and are in accordance to the applicable rules;
- wire type, section and length have been calculated considering environment conditions and in force norms;
- ground is functioning correctly: earth fault relay device works only if this connection is operating;
- that direction of the phases corresponds to the user plant phase rotation, and none of the phases has been accidentally connected to neutral.



## EARTHING WITHOUT GROUND FAULT INTERRUPTER

The protection against electric shock from contact indirect is ensured by the “electrical separation” with equipotential bonding between all the exposed conductive parts of the generating set.

The generating set is **NOT** equipped with a earth leakage circuit breaker because its windings are not connected to ground, hence the machine should **NOT** be intentionally connected to a grounding circuit.

The limitation of the extension of the electric circuit is very important for safety, do not power supply to electric plants with a length greater than 200 meters.

It is important that the power cords of the equipment are equipped with the protective conductor, yellow-green cable, in order to ensure the connection between the exposed conductive parts of the generating set and the equipment; this provision does not apply to the class II equipment (double insulation or reinforced insulation) recognizable by the symbol .

The cables must be suitable environment in which it operates. It should be noted that with temperatures below 5°C PVC cables become stiff and PVC insulation tends to cut to the first fold.

The protection by electrical separation is **NOT** suitable if the machine is destined to supply power complex plants or located in special environments with greater risk of electric shock.

In these cases it is necessary to adopt security measures electricity provided by law.

For EXAMPLE, you can install a GFI (Ground Fault Interrupter or Earth Leakage Circuit Breaker) high sensitivity 30mA, and grounding the Neutral of the generating set: this operation must be performed by a qualified electrician or at a authorized service provider.

The grounding of the generating set is now mandatory to ensure protection against indirect contact by means of the GFI.

Connect the generating set to an earthing system via a cable certain efficiency using the ground terminal (12) on the machine.

## EARTHING WITH GROUND FAULT INTERRUPTER

The grounding connection to an earthed installation **is obligatory** for all models equipped with a differential switch (circuit breaker). In these groups the generator star point is generally connected to the machine’s earthing; by employing the TN or TT distribution system, the differential switch guarantees protection against indirect contacts.

In the case of powering complex installations requiring or employing additional electrical protection devices, the coordination between the protection devices must be verified.

For the grounding connection, use the terminal (12); comply to local and/or current regulations in force for electrical installations and safety

## EARTHING WITH ISOMETER

Machines equipped with insulation resistance monitor allow intentionally not to connect the ground terminal PE (12) to an earthing system.

Located on the front of the machine the insulation resistance monitor has the function of continuously monitoring the ground insulation of live parts.

If the insulation resistance falls below the pre-set fault value, the insulation resistance monitor will interrupt the supply of the connected equipment.

It is important that the power cords of the devices are provided with the green-yellow circuit protective conductor, so as to ensure the bonding among all the grounds of the equipment and the ground of the machine; the latter provision does not apply to equipment with double insulation or reinforced insulation.

**NOTE:** it is possible to connect the PE terminal (12) to an own ground connection. In this case an IT earthing system is accomplished, this means with the active parts isolated from earth and the equipment cases grounded.

In this case, the insulation resistance monitor checks the insulation resistance of the active parts both towards case and ground, for example, the insulation towards ground of the power cables.



Check daily



**NOTE**

Do not alter the primary conditions of regulation and do not touch the sealed parts.



The engine is started and stopped by operating directly on the RGK420SA controller. Consult the controller manual for a complete understanding of its performance.

**STARTING**



By start-up of the generator the welding circuit is immediately operative, i.e. under voltage. Make sure that there are no unwished electrical contacts between the components of the outside welding circuit (electrode, electrode holder gun, workpiece, etc...).

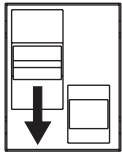

Verify that plugs will be disconnected or that the main switch will be off in order to assure the engine start without any electric load on. To switch on the controller when battery power is present at the terminals, turn the key switch

to the ON position. The device switches on and performs a self-test. The model and revision number appear on the display. With the controller switched on but before the motor is started, the pressure/temperature/battery charging icons indicate the state of the corresponding sensors.

To start the engine, press the START button for 1 second. The controller runs the engine start procedure but makes only one start attempt. If the attempt fails, you must repeat it, press START again.

Remember that when the machines with auto-idle have the signal set to "auto-idle" will remain at the minimum no. of revs (tickover) as long as no current is drawn. Drawing power will automatically raise the number of engine revs to the nominal value and likewise the tension in the alternator. Instead, by setting the auto-idle signal to "max", the engine revs will immediately rise to the nominal value and likewise the tension in the alternator.

For the machines with manual accelerator, it is necessary to accelerate the motor manually in order to reach the nominal tension.

We advice to start the machine at the minimum rpm, moving the acceleration control (16) to the minimum position or the AUTOIDLE selector (18) to AUTOIDLE position.

After the starting, keep the engine runs for a few minutes before the energy withdrawal. Check the tab:

TEMPERATURE	TIME
≤ - 20° C	5 min.
da - 20° C a -10° C	2 min.
da - 10° C a -5° C	1 min.
≥ 5° C	20 sec.

Start-up at low temperatures.

The engine has a good start-up to temperatures of -10°C. For start-up and use at temperature lower than -20°C please contact our Technical Assistance.

**STOPPING**

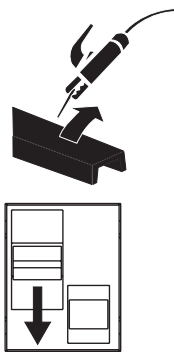

For shutdown under normal conditions, proceed as follows:  
Break the welding process in course.  
Break the production of a.c. auxiliary generation dividing the loads or opening the electrical protection interrupter.  
Let the engine run with no load for a few minutes.  
Turn to minimum rpm: AUTOIDLE selector (18) to AUTOIDLE position or acceleration control (16) to minimum position.

To stop the engine, turn the key switch back to the OFF position. The controller performs an engine cooling cycle (if required) and then runs the engine stop procedure. The controller switches off at the end of the engine stop procedure. The key can be removed in this position.

**EMERGENCY SHUTDOWN**

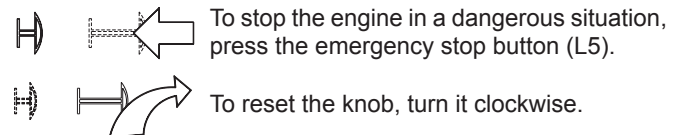

To stop the engine in a dangerous situation, press the emergency stop button (L5).

To reset the knob, turn it clockwise.

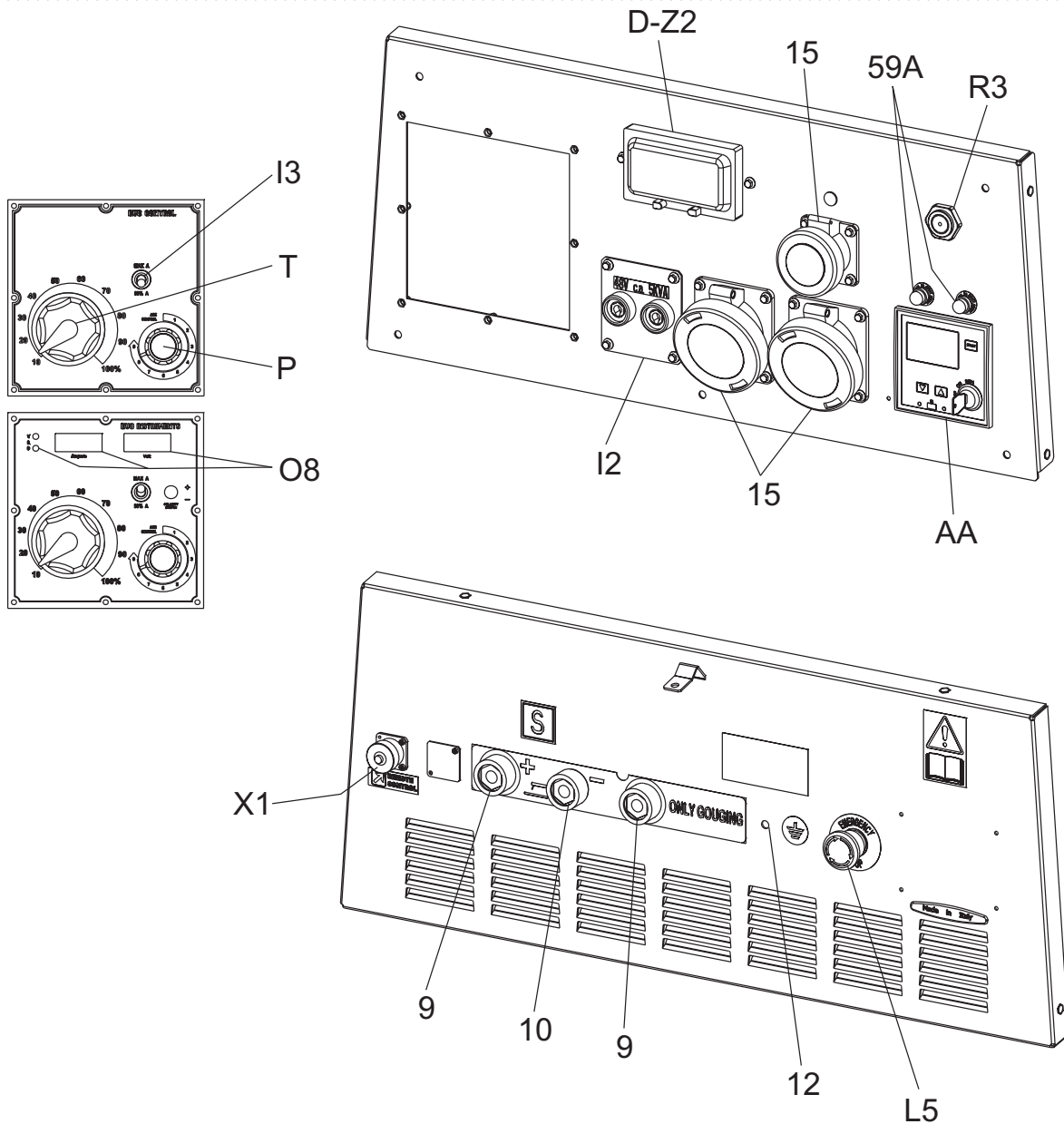

Pos.	Descrizione	Description	Description	Referenzliste
9	Presse di saldatura (only gouging)	Welding socket (only gouging)	Prise de soudage (only gouging)	Schweißbuchse (only gouging)
9	Presse di saldatura (+)	Welding socket (+)	Prise de soudage (+)	Schweißbuchse (+)
10	Presse di saldatura (-)	Welding socket (-)	Prise de soudage (-)	Schweißbuchse (-)
12	Presse di messa a terra	Earth terminal	Prise de mise à terre	Erdanschluss
15	Presse di corrente in c.a.	A.C. socket	Prises de courant en c.a.	Steckdose AC
59A	Protezione termica motore	Engine thermal protection	Protection thermique moteur	Thermoschutz Motor
AA	Unità controllo motore "RGK 420SA"	Engine control unit "RGK 420SA"	Protection moteur "RGK 420SA"	Motorschutz "RGK 420SA"
D	Interruttore differenziale (30 mA)	Ground fault interrupter (30 mA)	Interrupteur différentiel (30mA)	FI-Schalter (30 mA) GFI
I2	Presse di corrente 48V (c.a.)	48V A.C. socket	Prise de soudage 48V (c.a.)	Steckdose 48 V (AC)
I3	Commutatore riduzione scala saldatura	Welding range switch	Commutateur échelle soudage	Bereichsschalter Schweißstrom
L5	Pulsante stop emergenza	Emergency button	Bouton d'urgence	Notschalter
O8	Scheda strumenti V/A digitale scheda LED VRD	V/A digital instruments and led VRD PCB	Fiche instruments V/A numérique LED VRD	Steuerung V/A LED-Digitalkarte VRD
P	Regolatore arco di saldatura	Welding arc regulator	Régulateur arc de soudage	Kennlinienregler (Arc Force)
R3	Avvisatore acustico	Siren	Avertisseur sonore	Hupe
T	Regolatore corrente di saldatura	Welding current regulator	Régulateur courant soudage	Schweißstromregler
X1	Presse per comando a distanza	Remote control socket	Prise pour télécommande	Steckdose Fernbedienung
Z2	Interruttore magnetotermico	Thermal-magnetic circuit breaker	Interrupteur magnétothermique	Thermomagnetschalter

Pos.	Description	Function
9	c.c. socket (Only Gouging)	Outlet used only for cutting works
9	c.c. welding sockets (+)	Connection sockets for welding cables
10	c.c. socket only gouging	Outlet used only for cutting works
T	Welding current regulator	Allows the regulation of the welding current
P	Welding arc potentiometer	Turning clockwise the arc control is increased
X1	Remote control (connector)	Multiple connector for remote control.
O8	V/A digital instruments PCB	The device shows welding and voltage current.
I3	Switch for welding scale reduction	Placed on 50% it limits the maximum value of the welding current regulator (T), so permitting a more accurate regulation of the welding current
AA	Engine control unit "RGK 420SA"	<ul style="list-style-type: none"> <li>• Start and stop the machine</li> <li>• Fuel level gauge</li> <li>• Hour meter</li> <li>• Battery voltage</li> <li>• RPM</li> <li>• Three phase and single phase voltage</li> <li>• Frequency</li> <li>• Display with texts and icons for management alarms</li> <li>• Maintenance</li> <li>• Texts for parameters and alarms in 5 languages (EN - IT - FR - ES - DE).</li> </ul>
59A	Engine thermal switch	Protection against over-currents and short circuits in the engine electrical system.
R3	Siren	Gen-set acoustic alarm.
L5	Emergency stop button	To be pushed in case of danger. Immediate stop of the gen-set.
15	A.C. socket	AUX sockets for load connection.
I2	48V (A.C.) socket	48V outlet
D	Ground fault interrupter (30 mA)	Device for protection against not-direct contacts for TN and TT systems (neutral grounded to frame)
Z2	Thermal-magnetic circuit breaker	Protects the system connected to the outlets from overcurrent and shortcircuit.
12	Earth terminal	Ground connection point for gen-set.



**S** This symbol (Norm EN 60974-1 security standards for arc welders ) signifies that the welder can be used in areas with increased risk of electrical shock.

Assure the right ground connection (12) (when and if needed). For this purpose see chapter "GROUND CONNECTION".

**WARNING**

It is prohibited for any unauthorized persons to access areas adjacent to the engine driven welder or the welding process.

**WARNING**

The sockets, after the machine is started, also with no cables, are anyway under voltage.

**WARNING**

To reduce the risk of electromagnetic interferences, use the minimum length of welding cables and keep them near and down (ex. on the floor). The welding operations must take place far from any sensitive electronic device. Make sure that the unit is earthed. (see M20 and/or M25). In case the interference should last, adapt further disposition, such as: move the unit, use screened cables, line filters, screen the entire work area. In case the above mentioned operations are non sufficient, please contact our Technical Assistance Service.

**CAUTION**

With a welding cable length up to 10 m is suggested a section of 35 mm<sup>2</sup>; with longer cables a bigger section is required.

**CONNECT WELDING CABLES**

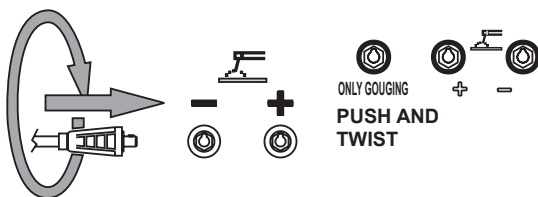

Fully insert the welding cable plugs into the corresponding sockets ("only gauging", 9+/-10-) turning them clockwise to lock them in position. Make sure that the ground clamp, whose cable must be connected to the + or - terminal, depending on the type of electrode, makes a good connection and is near to the welding position. Pay attention to the two polarities of the welding circuit, which must not come in electric contact between themselves.

Carefully tighten the output cables to the bushings; if loose, they can cause problems of overheating and damage the bushings, cables, etc.

When using the welder for air arc gouging connect the ground lead to the - socket and the gouging lead to the socket marked "only gouging" (if present).

**ADJUSTING THE WELDING CURRENT**

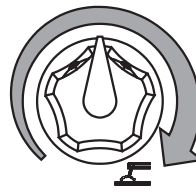

The welding current is regulated by turning knob "T" continuously. If set to the minimum (turned fully in an anticlockwise direction) it provides a current of approximately 20 A; if set to the maximum (turned fully in a clockwise direction) it gives a maximum current of approximately 600A (20V). Position welding current adjusting knob (T) in correspondance of the chosen current value, so as to obtain the necessary amperage, taking into account the diameter and the type of the electrode. For technical data see page M1.6

**REDUCTION SCALE SWITCH**



For small electrodes (up to Ø 4-200A) it is recommended to use the reduction scale switch (I3) allowing a more accurate regulation of the welding current (lever position at 50%).

**REMOTE CONTROL**

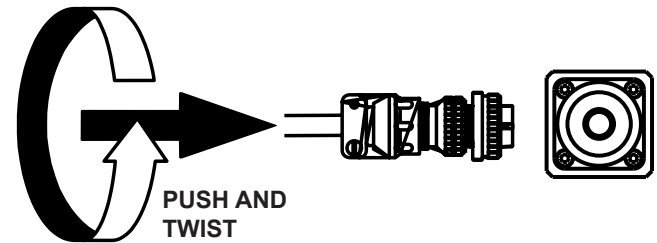

The welding machine is predisposed for connection to a remote control (optional) by means of the circular connector located on the front panel. Once the connection to the remote control has been made, the function of regulating the main potentiometer, located on the front panel, will be automatically switched to the remote control potentiometer.

The following table describes the functions of each of the connector's contacts.

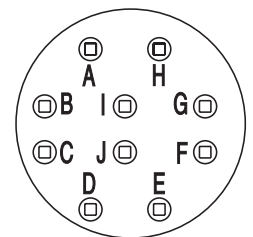

CONTACTS	DESCRIPTIONS
A (electric ground)	To the RC1 potentiometer - GND terminal
B	To the RC1 potentiometer - V <sub>CONTR</sub> terminal
C	To the RC1 potentiometer - V <sub>REF</sub> terminal
D	Non connected
E	Polarity switch version
F	Polarity switch version
G	Non connected
H	Non connected
I	Non connected
J	Non connected



## WELDING ARC CONTROL

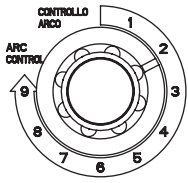

Set the welding arc using adjuster knob (P) so as to obtain, for the chosen current value, the best arc characteristic according to the electrode type and to the work to be performed.

## EVO INSTRUMENTS

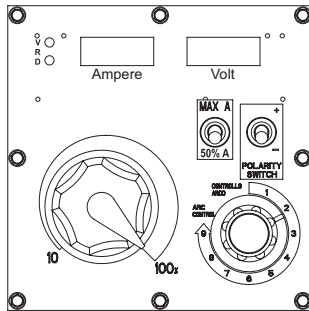

The following functions are available with the EVO INSTRUMENTS welding control panel:

- A/V digital instrument board
- VRD function (Voltage Reduction Device)
- Polarity inversion
- AUTOIDLE function

## A/V DIGITAL INSTRUMENTS BOARD



When the machine is switched on, the Ampere (Adc) instrument will display the welding current relative to the position of the knob (T) and the Volt (Vdc) instrument the open circuit voltage present on the welding sockets. By turning the knob (T) the Ampere (Adc) instrument will display the welding current value corresponding to the position of the knob, while the voltage value will remain the open circuit voltage. During the welding process the instruments will display the welding current and voltage values in real time

## VRD FUNCTION (Voltage Reduction Device)

The VRD function (standard on some models with A / V digital instrument board) fulfils the purpose of drastically reducing the harm which may result to a person from inadvertent contact with the electrode during non-welding pauses.

The protection acts by reducing the voltage to a safe value (typically <13V) each time the welding process is interrupted for a period longer than 3 seconds.



The proper operation of the VRD protection (in the models where it is implemented) is monitored by a couple of LEDs: one green and one red. During welding the red LED is off and the green one is on. When welding is stopped initially red LED turns on. After 3 seconds the green LED will turn on: this means that the voltage on the electrode has been reduced to a safe value.

## VRD SWITCH



It is possible to exclude the VRD function by acting on the switch located inside the electric box. The red LED will always be with no-load and the green LED will light up during welding.

## POLARITY INVERSION

(Optional on request only with the EVO INSTRUMENTS welding control panel)



It allows to have the positive or negative welding polarity to the electrode holder.

It is used specially in the first run with cellulosic electrodes to lower the bath temperature and therefore make welding on low-thickness pipes easier. To carry out the inversion of polarity, the action has given by the switch which is both on the front panel of the welding control and on the remote control. Selecting the inversion command the voltage on the welding sockets goes to zero, the power contactor is switched inside the machine and the voltage reappears at the welding sockets.

## AUTOIDLE

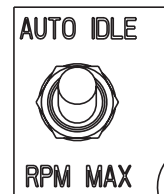

The Autoidle function, available only with EVO INSTRUMENT welding control panel, is enabled when the selector is on AUTOIDLE position.

When the machine is turned on, the engine will run at the minimum rpm.

After the recommended warm-up time, when welding or auxiliary current are required, the engine will switch automatically at the maximum rpm, allowing to have energy power.

Stopping the request of welding or auxiliary current, the engine will continue runs at maximum rpm for 15 seconds; ended this period, without any other current supply request, the engine will be back at the minimum rpm.

With MAX RPM position, the engine always runs at the maximum rpm.



## ATTENTION

For machines with AUTOIDLE function and manual acceleration lever, we recommend to use this control only in case of possible failure or malfunction of AUTOIDLE function.



## WARNING

It is absolutely forbidden to connect the unit to the public mains and/or another electrical power source .



**Access forbidden to area adjacent to electricity-generating group for all non-authorized personnel.**



## WARNING

For the canopy generator sets provided with doors, the following instruction shall be observed. During the normal operation, the doors of the engine compartment and/or the electrical box shall be kept closed, locked up if possible, as they must be considered in all respects as protection barriers. The access to the internal parts shall occur for maintenance purposes only, by qualified personnel and, in any case, when the engine is stopped.

The electricity-generating groups are to be considered electrical energy producing stations. The dangers of electrical energy must be considered together with those related to the presence of chemical substances (fuels, oils, etc.), rotating parts and waste products (fumes, discharge gases, heat, etc.).

### GENERATION IN AC (ALTERNATING CURRENT)

Before each work session check the efficiency of the ground connection for the electricity-generating group if the distribution system adopted requires it, such as, for example, the TT and TN systems.

Check that the electrical specifications for the units to be powered - voltage, power, frequency - are compatible with those of the generator. Values that are too high or too low for voltage and frequency can damage electrical equipment irreparably. In some cases, for the powering of three-phase loads, it is necessary to ensure that the cyclic direction of the phases corresponds to the installation's requirements.

Connect the electric devices to be powered to the AC sockets, using suitable plugs and cables in prime condition.

Before starting up the group, make certain no dangerous situations exist on the installation to be powered.

Check that the thermal-magnetic switch (Z2) is in the OFF position (input lever in downward position).

Start up the electricity-generating group, positioning the thermal-magnetic switch (Z2) and differential switch (D) to ON (input lever in upward position).

Before powering on the utilities, check that the voltmeter (N) and frequency meter (E2) indicate nominal values; in addition, check on the voltmeter change-over switch (H2) (where it is assembled) that the three line voltages are the same.

In the absence of a load, the values for voltage and frequency can be greater than their nominal values. See sections on VOLTAGE and FREQUENCY.

### OPERATING CONDITIONS

#### POWER

The electrical power expressed in kVA on an electricity-generating group is the available output power to the reference environmental conditions and nominal values for: voltage, frequency, power factors (cos  $\varphi$ ).

During the use of the electricity-generating group NEVER EXCEED the power indications, paying careful attention when several loads are powered simultaneously.

#### VOLTAGE

In some types of generators (asynchronous) the no-load voltage can be even higher than 10% with respect to its nominal value; for example, for nominal voltage, three-phase 400Vac or single-phase 230Vac, the no-load voltage can be between 425-440V (three-phase) and 240-252V (single-phase).

The full load voltage could also be 10% lower than its nominal value with balanced loads and with a rotation speed variation of less than 4%.

#### FREQUENCY

The frequency is a parameter that is directly dependent on the motor's rotation speed. Depending on the type of alternator, 2 or 4 pole, we will have a frequency of 50/60 Hz with a rotation speed of 3000/3600 or 1500/1800 revolutions per minute.

The frequency, and therefore the number of motor revolutions, is maintained constant by the motor's speed regulation system. Generally, this regulator is of a mechanical type and presents a droop from no-load to nominal load which is less than 5 % (static or droop), while under static conditions precision is maintained within  $\pm 1\%$ . Therefore, for generators at 50Hz the no-load frequency can be 52-52.5 Hz, while for generators at 60Hz the no-load frequency can be 62.5-63Hz.

In some motors or for special requirements the speed regulator is electronic; in these cases, precision under static operating conditions attains  $\pm 0.25\%$ , and the frequency is maintained constant in operation from no-load to load (isochronal operation).

#### POWER FACTOR - COS $\varphi$

The power factor is a value which depends on the load's electrical specifications; it indicates the ratio between the Active Power (kW) and Apparent Power (kVA). The apparent power is the total power necessary for the load, achieved from the sum of the active power supplied by the motor (after the alternator has transformed the mechanical power into electrical power), and the Reactive Power (kVAR) supplied by the alternator. The nominal value for the power factor is  $\cos \varphi = 0,8$ ; for different values comprised between 0.8 and 1 it is important during usage not to exceed the declared active power (kW), so as to not overload the electricity-generating group motor; the apparent power (kVA) will diminish proportionally to the increase of  $\cos \varphi$ . For  $\cos \varphi$  values of less than 0.8 the alternator must be downgraded, since at equal apparent power the alternator should supply a greater reactive power. For reduction coefficients, contact the Technical Service Department.

#### STARTING ELECTRIC MOTORS

The starting of electric motors by a generator can be critical due to the high starting currents that the electric motor requires (I<sub>avv.</sub> = Up to 8-10 times the rated current I<sub>n</sub>).

With asynchronous alternators, the motor starting current must not exceed the rated current of the alternator, which is why asynchronous alternators are not recommended for starting electric motors.



**ELECTRIC PROTECTIONS**

**THERMAL-MAGNETIC SWITCH**

**NOTE:** for some types of alternators (asynchronous alternators) it is not necessary to protect the three-phase output against short circuits and overcurrents, as the asynchronous alternator self-protects itself.

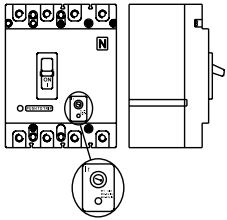

The electricity-generating group is protected against short-circuits and against overloads by a thermal-magnetic switch (Z2) situated upstream from the installation. Operating currents, both thermic and magnetic, can be fixed or adjustable in relation to the switch model.

In models with adjustable operating current **do not modify** the settings, since doing so can compromise the installation's protection or the electricity-generating group's output characteristics. For eventual variations, contact our Technical Service Department.

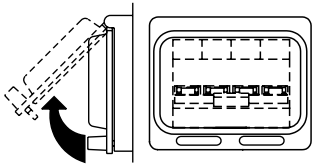

The intervention of the protection feature against overloads is not instantaneous, but follows a current overload/time outline; the greater the overload the less

the intervention. Furthermore, keep in mind that the nominal operating current refers to an operating temperature of 30°C, so that each variation of 10°C roughly corresponds to a variation of 5% on the value of nominal current.

In case of an intervention on the part of the thermal magnetic protection device, check that the total absorption does not exceed the electricity-generating group's nominal current.

**DIFFERENTIAL SWITCH**

The differential switch or differential relay guarantee protection against indirect contacts due to malfunction currents towards the ground. When the device detects a malfunction current that is higher than the nominal current or the set current, it intervenes by cutting off power to the circuit connected.

In the case of an intervention by the differential switch, check that there are no sheathing defects in the installation: connection cables, sockets and plugs, utilities connected.

Before each work session, check the operation of the differential protection device by pressing the test key. The

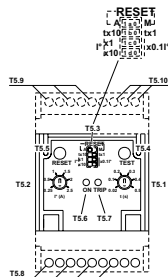
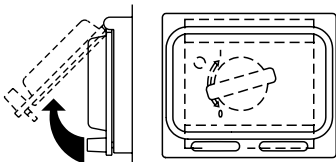

electricity-generating group must be in operation, and the lever on the differential switch must be in the ON position.

**THERMIC PROTECTION**

Generally present to protect against overloads on an individual power socket c.a.

When the nominal operating current has been exceeded, the protection device intervenes by cutting off power to the socket. The intervention of the protection device against overloads is not instantaneous, but follows a current overload/time outline; the greater the overload the less the intervention.

In case of an intervention, check that the current absorbed by the load does not exceed the protection's nominal operating current. Allow the protection to cool off for a few minutes before resetting by pressing the central pole.



**ATTENTION**

Do not keep the central pole on the thermic protection forcefully pressed to prevent its intervention.

**SIMULTANEOUS USE**

The welder's alternator permits the simultaneous use of auxiliary power and welding current. The auxiliary power available to the AC plugs (15) diminishes as the welding current drawn increases.

The table on page M52 TECHNICAL SPECIFICATIONS shows the amount of auxiliary power available as the welding current varies.

**COMBINED USE**

The output available from the various auxiliary power sockets is limited, not only by the declared output of the unit but also by the capacity of each individual socket.



## WELDING WITH ELECTRODES

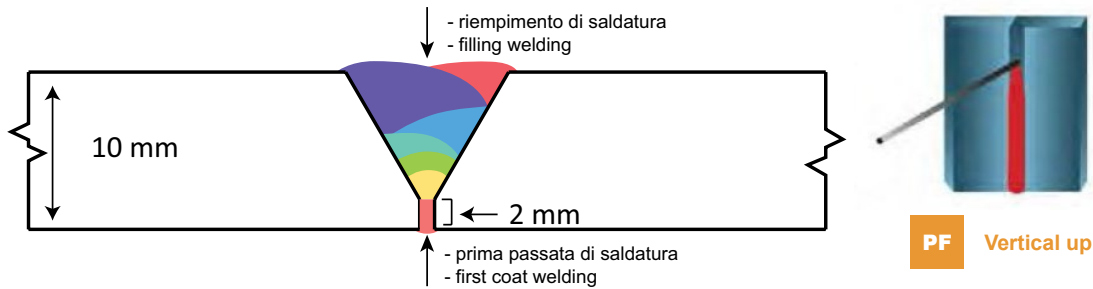

### CELLULOSE E 6010 - FIRST COAT WELDING

Welding thickness (mm)	Diameter electrode (mm)	Ampère	Arc Control 1/9	Recommended electrode polarity
10,0	3,2	60/80	6	DC +
10,0	4	70/90	7	DC +

### BASIC E 7016 - FILLING WELDING

Welding thickness (mm)	Diameter electrode (mm)	Ampère	Arc Control 1/9	Recommended electrode polarity
10,0	2,5	50/70	3	DC +

### BASIC E 7018 - FILLING WELDING

Welding thickness (mm)	Diameter electrode (mm)	Ampère	Arc Control 1/9	Recommended electrode polarity
10,0	2,5	50/70	3	DC +
10,0	3,25	90/100	3	DC +
10,0	4	100/130	2	DC +



PF Vertical down

### CELLULOSE E 6010 - FIRST COAT WELDING

Welding thickness (mm)	Diameter electrode (mm)	Ampère	Arc Control 1/9	Recommended electrode polarity
10,0	3,2	60/80	6/7	DC -
10,0	4	70/90	7	DC -

The information here below are to be intended only as indicative since the above norm is much larger.  
For further details please see the specific norms and/or the manufacturers of the product to be used in the welding process.

**RUTILE ELECTRODES: E 6013**

Easily removable fluid slag, suitable for welding in all position.  
Rutile electrodes weld in d.c. with both polarities (electrode holder at + or -) and in a.c..  
Suitable for soft steels R-38/45 kg/mm<sup>2</sup>. Also for soft steels of lower quality.

**BASIC ELECTRODES: E 7015**

Basic electrodes weld only in d.c. with inverse polarity (+ on the electrode holder) ; there are also types for a.c.  
Suitable for impure carbon steels. Weld in all position.

**HIGH YIELD BASIC ELECTRODES: E 7018**

The iron contained in the coating increases the quality of metal added. Good mechanical properties. Weld in all position. Electrode holder at + (inverse polarity). Weld deposit of nice aspect, also vertical. Workable; high yield.  
Suitable for steels with high contents of sulphur (impurities).

**CELLULOSIC ELECTRODES: E 6010**

Cellulosic electrodes weld only in d.c. with polarity + electrode holder - ground clamp.  
Special for steels run on pipes with R max 55 kg/mm<sup>2</sup>. Weld in all position. volatile slag.

**ELECTRODES IDENTIFICATION ACCORDING TO A.W.S. STANDARDS**

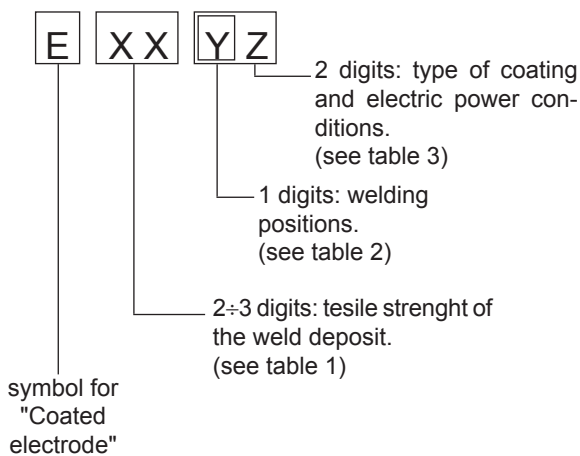

Number	Strength	
	K.s.l.	Kg/mm <sup>2</sup>
60	60.000	42
70	70.000	49
80	80.000	56
90	90.000	63
100	100.000	70
110	110.000	77
120	120.000	84

Table 1

1	for all positions
2	for plane and vertical
3	for plane position only

Table 2

N°	Description
10	Cellulose electrodes for d.c.
11	Cellulose electrodes for a.c.
12	Rutile electrode for d.c.
13	Rutile electrode for a.c.
14	High yield rutile electrodes
15	Basic electrodes for d.c.
16	Basic electrodes for a.c.
18	High yield basic electrodes for d.c. (inverse polarity)
20	Acid electrodes for flat or front position welding for d.c. (- pole) and for a.c.
24	High yield rutile electrodes for flat or front plane position welding for d.c. and a.c.
27	High yield acid electrodes for flat or front plane position welding for d.c. (- pole) and a.c..
28	High yield basic electrodes for flat or front plane position welding for d.c. (inverse polarity)
30	Extra high yield acid electrodes, extra high penetration if required, for flat position welding only for d.c. (- pole) and a.c.



Table 3

<i>Problem</i>	<i>Possible cause</i>	<i>Solution</i>
<b>ENGINE</b>		
P1 - The motor does not start up	1) Emergency button (L5) pressed 2) Preheating (where it is assembled)  3) Engine control unit or starting key faulty 4) Battery low  5) Battery cable terminals loose or corroded 6) Start-up motor defective 7) No fuel or air in feed circuit 8) Malfunction on feed circuit: defective pump, injector blocked, etc. 9) Air filter or fuel filter clogged 10) Air in the gasoil filter 11) Motor stopping device defective 12) Malfunction on electrical power circuit on generator control panel	1) Unblock 2) Lacking or insufficient preheating phase for sparkplugs. Malfunction in circuit: repair 3) Replace 4) Recharge or replace. Check the battery charge circuit on motor and automatic panel 5) Tighten and clean. Replace if corroded 6) Repair or replace 7) Refill tank, un-aerate the circuit 8) Ask for intervention of Service Department  9) Clean or replace 10) Take the air out filling the filter with gasoil 11) Replace 12) Check and repair
P2 - The motor does not accelerate. Inconstant speed	1) Air filter or fuel filter clogged 2) Malfunction on feed circuit: defective pump, injector blocked, etc. 3) Oil level too high 4) Motor speed regulator defective	1) Clean or replace 2) Ask for intervention of Service Department  3) Eliminate excess oil 4) Ask for intervention of Service Department
P3 - Black smoke	1) Air filter clogged 2) Overload 3) Injectors defective. Injection pump requires calibration	1) Clean or replace 2) Check the load connected and diminish 3) Ask for intervention of Service Department
P4 - White smoke	1) Oil level too high 2) Motor cold or in prolonged operation with little or no load 3) Segments and/or cylinders worn out	1) Eliminate excess oil 2) Insert load only with motor sufficiently hot  3) Ask for intervention of Service Department
P5 - Too little power provided by motor	1) Air filter clogged 2) Insufficient fuel distribution, impurities or water in feed circuit 3) Injectors dirty or defective	1) Clean or replace. 2) Check the feed circuit, clean and refill once again 3) Ask for intervention of Service Department
P6 - Low oil pressure	1) Oil level insufficient 2) Air filter clogged 3) Oil pump defective 4) Alarm malfunction	1) Reset level. Check for leaks 2) Replace filter 3) Ask for intervention of Service Department 4) Check the sensor and electrical circuit
P7 - High temperature	1) Overload 2) Insufficient ventilation  3) Insufficient coolant liquid (Only for water cooled motors)  4) Water radiator or oil clogged (where it is assembled) 5) Water circulating pump defective (Only for water cooled motors) 6) Injectors defective. Injection pump requires calibration 7) Alarm malfunction	1) Check the load connected and diminish 2) Check the cooling vent and relative transmission belts 3) Restore level. Check for leaks or breakage in the entire cooling circuit, pipes, couplings, etc. 4) Clean cooling fins on radiator  5) Ask for intervention of Service Department 6) Ask for intervention of Service Department 7) Check the sensor and electrical circuit

<i>Problem</i>	<i>Possible cause</i>	<i>Solution</i>
<b>WELDING</b>		
P1 - No welding current but auxiliary output is OK	1) Potentiometer defect in welding current control 2) Welding current signal interrupter 3) Current sensor faulty 4) Defect in card 5) Defect in diode bridge	1) Replace potentiometer 2) Check that cables from current sensor to card are in perfect state 3) Replace current sensor 4) Replace card 5) Replace diode bridge
P2 - There is welding but non penetration	1) Defective welding arc control potentiometer 2) Defective welding current signal 3) Current sensor faulty 4) Defect in card 5) Defect in diode bridge	1) Replace potentiometer 2) Check the continuity of the welding potentiometer and relative connections 3) Replace current sensor 4) Replace card 5) Replace diode bridge
P3 - Defect in welding, high and discontinued sparks	1) Defective welding current signal  2) Defect in diode bridge 3) Defect in card	1) Replace current sensor Check that cables from current sensor to card are in perfect state 2) Replace diode bridge 3) Replace card
P4 - No welding output and no auxiliary power output	1) Short circuit in wiring  2) Defective condenser  3) Defective stator  4) Short circuited diode bridge	1) Check the wiring inside the welder for a short circuit between cables or to ground 2) With engine OFF, discharge the capacitor box, disconnect the wires to the capacitor box and measure the capacity value 3) If the condenser box is OK, disconnect all leads from the stator except for those going to the condenser box and check the output from the alternator. If there is no output from the welding winding and the auxiliary winding, replace the stator 4) If there is output from all windings reconnect the diode bridge and check if there is welding current. If not the diode bridge is defective, replace



<i>Problem</i>	<i>Possible cause</i>	<i>Solution</i>
<b>GENERATION</b>		
P1 - Absence of output voltage	1) Main switch in OFF position 2) Differential protection device tripped (Differential switch, differential relay)  3) Protection tripped due to overload 4) Defective electric protections 5) Defective condenser  6) Alternator defective	1) Check and switch ON 2) Check on the entire installation: cables, connections, utilities connected have no defective sheathing which may cause incorrect currents to ground 3) Check the load and diminish 4) Replace 5) With engine OFF, discharge the capacitor box, disconnect the wires to the capacitor box and measure the capacity value 6) If the condenser box is OK, disconnect all leads from the stator except for those going to the condenser box and check the output from the alternator. If there is no output from the welding winding and the auxiliary winding, replace the stator. Ask for intervention of Service Department
P2 - No-load voltage too low or too high	1) Incorrect motor running speed 2) Defective condenser 3) Alternator defective	1) Regulate speed to its nominal no-load value 2) See previous point P1 3) See previous point P1
P3 - Corrected no-load voltage too low with load	1) Incorrect motor running speed due to overload 2) Load with $\cos \varphi$ less than 0.8 3) Defective condenser 4) Alternator defective	1) Check the load connected and diminish  2) Reduce or rephase load 3) See previous point P1 4) See previous point P1
P4 - Unstable tension	1) Contatti incerti 2) Irregolarità di rotazione del motore 3) Defective condenser 4) Alternator defective	1) Check electrical connections and tighten 2) Ask for intervention of Service Department 3) See previous point P1 4) See previous point P1

 <b>WARNING</b>		
	<ul style="list-style-type: none"> <li>• Have <b>qualified</b> personnel do maintenance and troubleshooting work.</li> <li>• Stop the engine before doing any work inside the machine. If for any reason the machine must be operated while working inside, <b>pay attention</b> moving parts, hot parts (exhaust manifold and muffler, etc.) electrical parts which may be unprotected when the machine is open.</li> <li>• Remove guards only when necessary to perform maintenance, and replace them when the maintenance requiring their removal is complete.</li> <li>• Please wear the appropriate clothing and make use of the PPE (Personal Protective Equipment), according to the type of intervention (protective gloves, insulated gloves, glasses).</li> <li>• Do not modify the components if not authorized.</li> </ul> <p>- See pag. M1.1 -</p>	
<b>MOVING PARTS can injure</b>		<b>HOT surface can hurt you</b>

**NOTE**

By maintenance at care of the utilizer we intend all the operatios concerning the verification of mechanical parts, electrical parts and of the fluids subject to use or consumption during the normal operation of the machine.

For what concerns the fluids we must consider as maintenance even the periodical change and or the refills eventually necessary.

Maintenance operations also include machine cleaning operations when carried out on a periodic basis outside of the normal work cycle.

The repairs **cannot be considered** among the maintenance activities, i.e. the replacement of parts subject to occasional damages and the replacement of electric and mechanic components consumed in normal use, by the Assistance Authorized Center as well as by manufacturer.

The replacement of tires (for machines equipped with trolleys) must be considered as repair since it is not delivered as standard equipment any lifting system.

The periodic maintenance should be performed according to the schedule shown in the engine manual. An optional hour counter (M) is available to simplify the determination of the working hours.

**VENTILATION**

Make certain there are no obstructions (rags, leaves or other) in the air inlet and outlet openings on the machine, alternator and motor.

**ELECTRICAL PANELS**

Check condition of cables and connections daily. Clean periodically using a vacuum cleaner, **DO NOT USE COMPRESSED AIR.**

**DECALS AND LABELS**

*All warning and decals should be checked once a year and **replaced** if missing or unreadable.*

**STRENUOUS OPERATING CONDITIONS**



Under extreme operating conditions (frequent stops and starts, dusty environment, cold weather, extended periods of no load operation, fuel with over 0.5% sulphur content) do maintenance more frequently.

**BATTERY WITHOUT MAINTENANCE  
DO NOT OPEN THE BATTERY**

The battery is charged automatically from the battery charger circuit supplied with the engine.

Check the state of the battery from the colour of the warning light which is in the upper part.

- Green colour: battery OK
- Black colour: battery to be recharged
- White colour: battery to be replaced

 <b>IMPORTANT</b>
 <p>In the maintenance operations avoid that polluting substances, liquids, exhausted oils, etc. bring damage to people or things or can cause negative effects to surroundings, health or safety respecting completely the laws and/or dispositions in force in the place.</p>

**ENGINE AND ALTERNATOR**

**PLEASE REFER TO THE SPECIFIC MANUALS PROVIDED.**

Every engine and alternator manufacturer has maintenance intervals and specific checks for each model: it is necessary to consult the specific engine or alternator USER AND MAINTENANCE manual.

 <b>NOTE</b>
<p>THE ENGINE PROTECTION NOT WORK WHEN THE OIL IS OF LOW QUALITY BECAUSE NOT CHARGED REGULARLY AT INTERVALS AS PRESCRIBED IN THE OWNER'S ENGINE MANUAL.</p>





## IMPORTANT

The engine and alternator manufacturers indicate specific maintenance and control intervals: it is obligatory to consult the books, OPERATION AND MAINTENANCE of the engine and alternator provided with the generator you are using. If such documents are not supplied with the generator set, ask for a copy to the customer service.

The information given in the table is only indicative. Specific instructions are given in the operation manuals.

MAINTENANCE INTERVALS	Daily	Every 50 h	Every 250 h	Every 500 h	Every 1000 h	Every 1500 h	Every 2000 h	Every 3000 h
Check and refill engine coolant	○							
Check and clean radiator fins		○						
Check and adjust cooling fan V-belt		○ 1st time	○ 2nd and after					
Drain, flush and refill cooling system with new coolant					◇ or every year whichever comes first			
Adjust intake/exhaust valve clearance					●			
Lap intake/exhaust valve seat							●	
Check battery		○						
Check engine oil level	○							
Replace engine oil and filter		◇ <sup>1</sup> 1st time	◇ <sup>2</sup> 2nd and after					
Inspect, clean and test fuel injectors, if necessary						●		
Inspect turbocharger								●
Inspect, clean and test EGR valve								●
Clean EGR lead valve								●
Clean EGR cooler						●		
Check and refill fuel tank level	○							
Drain fuel filter/water separator	○							
Check fuel filter/water separator	○							
Clean fuel filter/water separator				○				
Replace fuel filter				◇				
Clean or replace air cleaner element		○	◇					
Overall visual check daily	○							

○ = Check

◇ = Replace

● = Contact your authorized Yanmar industrial engine dealer or distributor for these maintenance services

◇<sup>1</sup> = IDI Models

◇<sup>2</sup> = DI Models

**STORAGE**

In case the machine should not be used for more than 30 days, make sure that the room in which it is stored presents a suitable shelter from heat sources, weather changes or anything which can cause rust, corrosion or damages to the machine.

☛ Have **qualified** personnel prepare the machine for storage.

**GASOLINE ENGINE**

Start the engine: It will run until it stops due to the lack of fuel.

Drain the oil from the engine sump and fill it with new oil (see page M25).

Pour about 10 cc of oil into the spark plug hole and screw the spark plug, after having rotated the crankshaft several times.

Rotate the crankshaft slowly until you feel a certain compression, then leave it.

In case the battery, for the electric start, is assembled, disconnect it.

Clean the covers and all the other parts of the machine carefully.

Protect the machine with a plastic hood and store it in a dry place.

**DIESEL ENGINE**

For short periods of time it is advisable, about every 10 days, to make the machine work with load for 15-30 minutes, for a correct distribution of the lubricant, to recharge the battery and to prevent any possible blocking of the injection system.

For long periods of inactivity, turn to the after sales service of the engine manufacturer.

Clean the covers and all the other parts of the machine carefully.

Protect the machine with a plastic hood and store it in a dry place.

**DISASSEMBLE**

☛ Have **qualified** personnel disassemble the machine and dispose of the parts, including the oil, fuel, etc., in a correct manner when it is to be taken out of service.

As disassemble we intend all operations to be made, at utilizer's care, at the end of the use of the machine.

This comprises the dismantling of the machine, the subdivision of the several components for a further reutilization or for getting rid of them, the eventual packing and transportation of the eliminated parts up to their delivery to the store, or to the bureau entrusted to the disassemble or to the storage office, etc.

The several operations concerning the disassemble, involve the manipulation of fluids potentially dangerous such as: lubricating oil and battery electrolyte.

The dismantling of metallic parts liable to cause injuries or wounds, must be made wearing heavy gloves and using suitable tools.

The getting rid of the various components of the machine must be made accordingly to rules in force of law a/o local rules.

**Particular attention must be paid when getting rid of: lubricating oils, battery electrolyte, and inflammable liquids such as fuel, cooling liquid.**

The machine user is responsible for the observance of the norms concerning the environment conditions with regard to the elimination of the machine being disassemble and of all its components.

In case the machine should be disassemble without any previous disassembly it is however compulsory to remove:

- tank fuel
- engine lubricating oil
- cooling liquid from the engine
- battery

**NOTE:** The manufacturer is involved with disassembling the machine **only** for the second hand ones, when not reparable.



This, of course, after authorization.

In case of necessity for first aid and fire prevention, see page M2.1.

**IMPORTANT**

In the storage and cust off operations avoid that polluting substances, liquids, exhausted oils, etc. bring damage to people or things or can cause negative effects to surroundings, health or safety respecting completely the laws and/or dispositions in force in the place.



GENERATOR		TS 400 YS	
Three-phase generation	16 kVA / 400 V / 23.1 A		
Single-phase generation	10 kVA / 230 V / 43.5 A		
Single-phase generation	5 kVA / 110 V / 45.5 A		
Single-phase generation	5 kVA / 48 V / 104 A		
Frequency	50 Hz		
ALTERNATOR		self-excited, self-regulated, brushless	
Type	Three-phase, asynchronous		
Insulating class	H		
ENGINE			
Mark / Model	YANMAR 4TNV88 (STAGE V)		
Type / Cooling system	Diesel 4-Stroke / Air		
Cylinders / Displacement	4 / 2190 cm <sup>3</sup>		
Net output (stand-by)	18 kW (24.5 HP)		
Speed	1500 rpm		
Fuel consumption (welder 60%)	3.15 l/h		
Engine oil capacity	7.4 l		
Starter	Electric		
GENERAL SPECIFICATION			
Tank capacity	60 l		
Running time (welder 60%)	19 h		
Protection	IP 23		
*Dimensions max. on base LxIhx (mm)	1720x850x1128		
*Weight	750 Kg		
Measured acoustic power LwA (pressure LpA)	94 dB(A) (69 dB(A) @ 7 m) 		
Guaranteed acoustic power LwA (pressure LpA)	95 dB(A) (70 dB(A) @ 7 m) 		

\* Dimensions and weight are inclusive of all parts without wheels and towbar

**POWER**

Declared power according to ISO 3046-1 (temperature 25°C, 30% relative humidity, altitude 100 m above sea level).  
It's admitted overload of 10% each hour every 12 h.  
In an **approximative** way one reduces: of 1% every 100 m altitude and of 2.5% for every 5°C above 25°C.

**ACOUSTIC POWER LEVEL**

**ATTENTION:** The concrete risk due to the machine depends on the conditions in which it is used. Therefore, it is up to the end-user and under his direct responsibility to make a correct evaluation of the same risk and to adopt specific precautions (for instance, adopting a I.P.D. -Individual Protection Device)

**Acoustic Noise Level (LwA) - Measure Unit dB(A):** it stands for acoustic noise released in a certain delay of time. This is not submitted to the distance of measurement.

**Acoustic Pressure (Lp) - Measure Unit dB(A):** it measures the pressure originated by sound waves emission. Its value changes in proportion to the distance of measurement.

The here below table shows examples of acoustic pressure (Lp) at different distances from a machine with Acoustic Noise Level (LwA) of 95 dB(A)

Lp a 1 meter = 95 dB(A) - 8 dB(A) = 87 dB(A)

Lp a 7 meters = 95 dB(A) - 25 dB(A) = 70 dB(A)

Lp a 4 meters = 95 dB(A) - 20 dB(A) = 75 dB(A)

Lp a 10 meters = 95 dB(A) - 28 dB(A) = 67 dB(A)

**PLEASE NOTE:** the symbol  when with acoustic noise values, indicates that the device respects noise emission limits according to 2000/14/CE directive.



**CAUTION**

**RUNNING-IN**

During the first 50 hours of operation, do not use more than 60% of the maximum output power of the unit and check the oil level frequently, in any case please stick to the rules given in the engine use manual.

**D.C. WELDING (CONSTANT CURRENT)**

**TS 400 YS**

**Welding processes**

SMAW (STIK - Shielded Metal Arc)  
GTAW (TIG Contact starting)

**Welding current**

20A ÷ 400A

**Welding current electronic regulation**

continues on 2 scales: 20A ÷ 200A / 20A ÷ 400A

**Service**

400A - 60% / 350A - 100%

**Open circuit voltage (no-load voltage)**

72 Vcc (77.5 Vd.c. peak)

ENGLISH

ENGLISH

**OUTPUT CHARACTERISTIC**

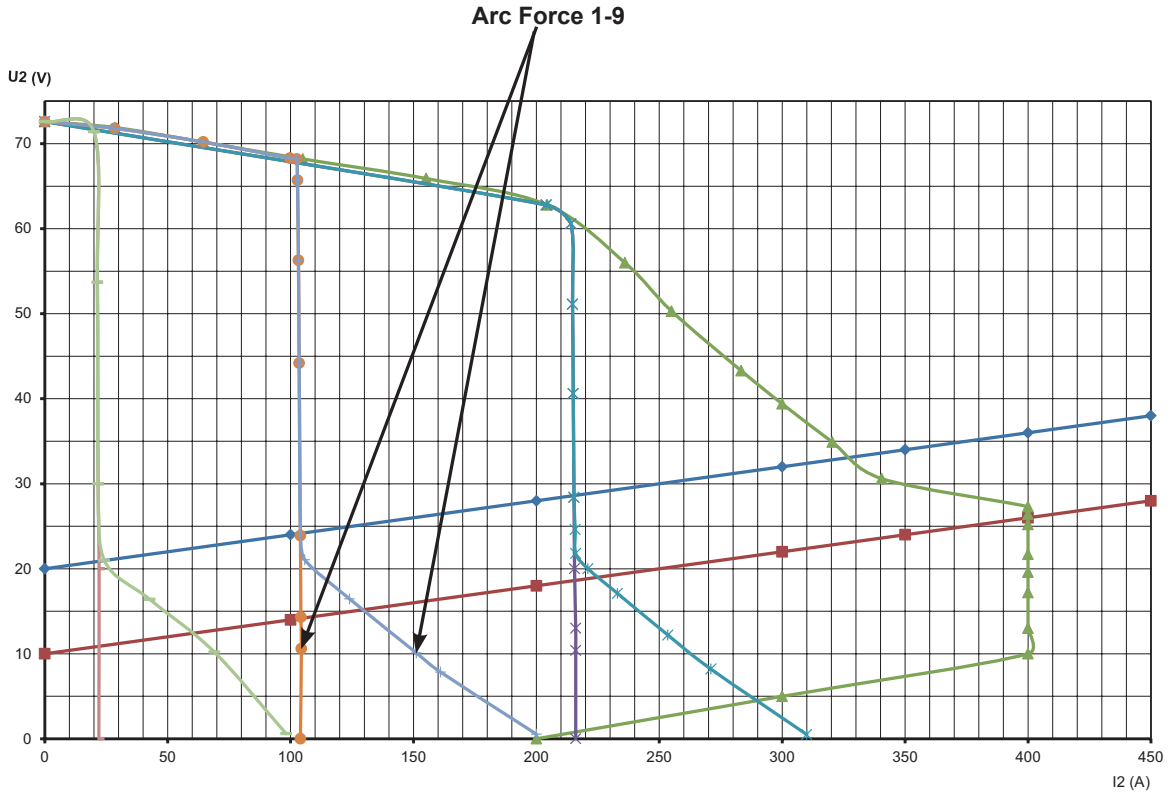

**SIMULTANEOUS UTILIZATION FACTORS**

In case **Welding** and **Generation** can be used simultaneously, however, the engine **cannot** be overloaded. The table/graphic below gives the maximum limits to be respected:

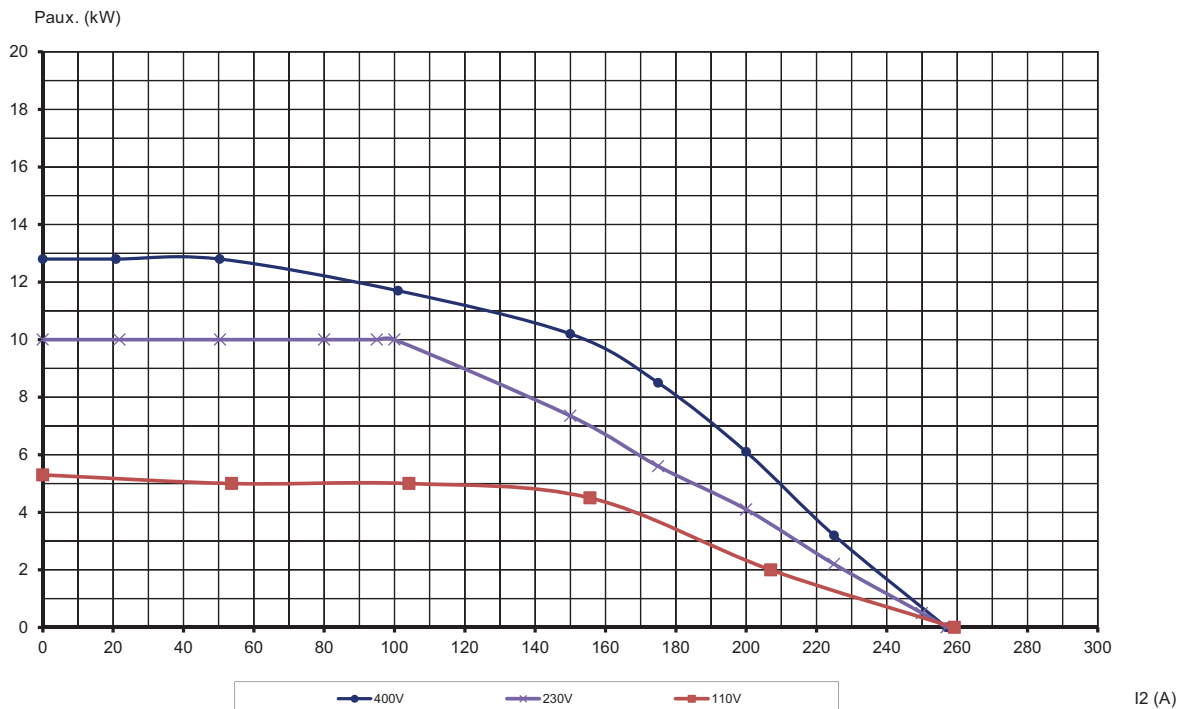

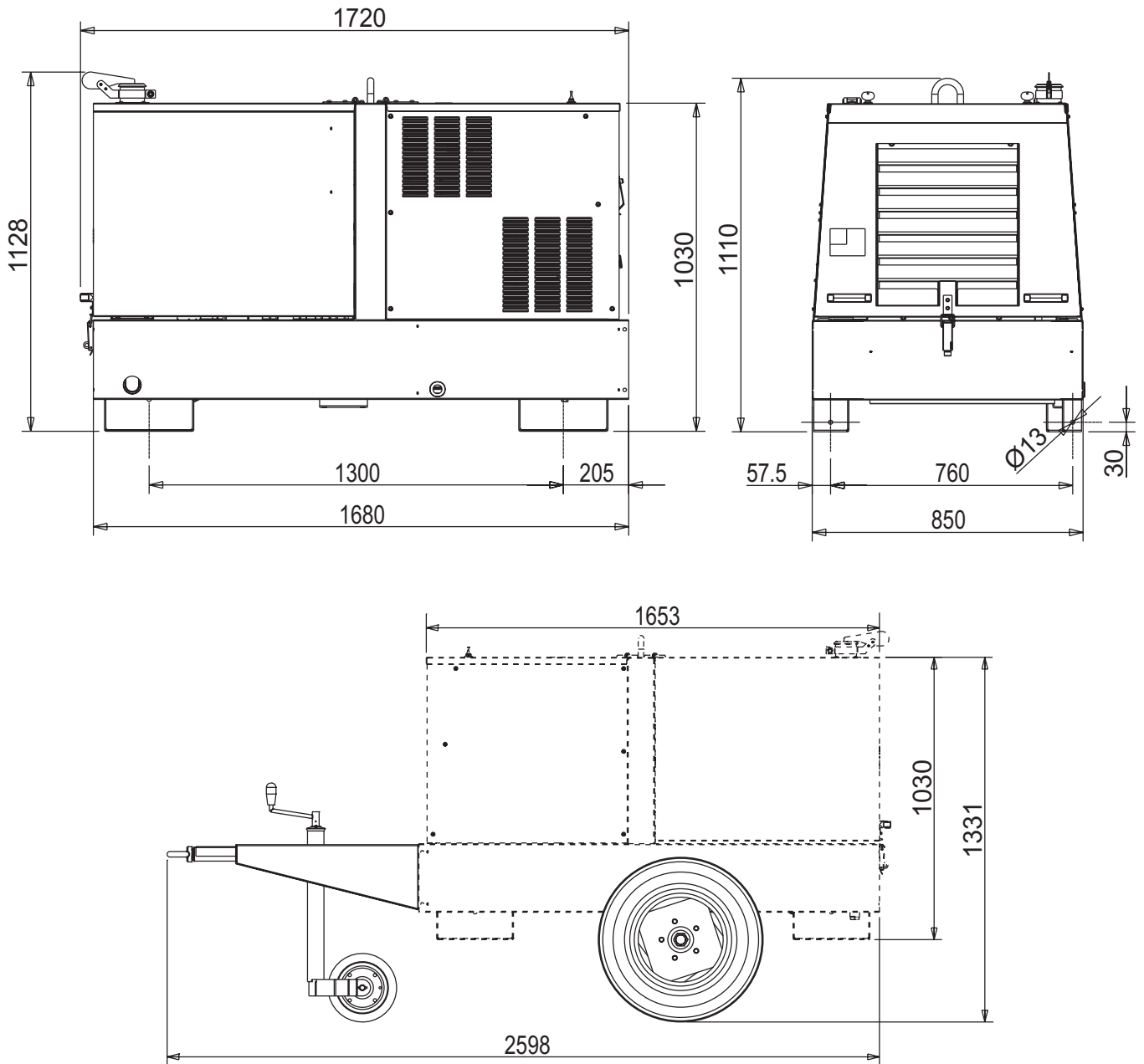



Lined writing area consisting of a dotted top line followed by 25 horizontal solid lines.











**MOSA**

**MOSA div. della BCS S.p.A.**

Viale Europa, 59 20090 Cusago (Milano) Italy

Tel. +39 - 0290352.1 Fax +39 - 0290390466 [www.mosa.it](http://www.mosa.it)

